

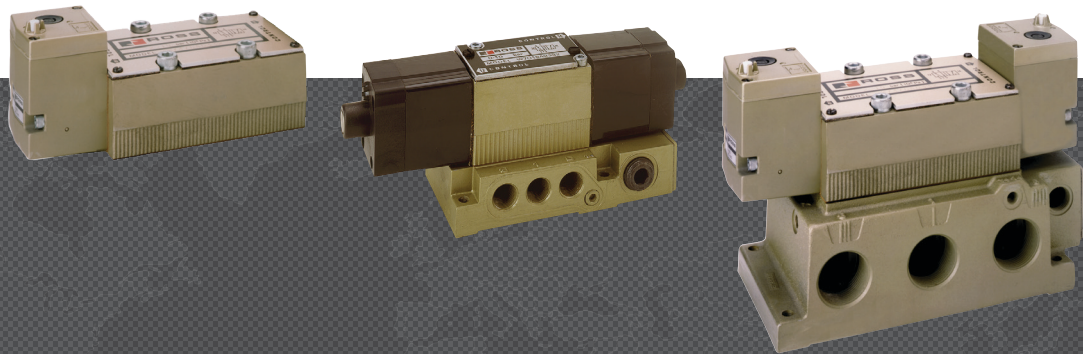

DIRECTIONAL CONTROL ANSI VALVES W70 & W74 SERIES

PRODUCT CATALOG



ANSI Valves W70 Series

Product Overview

The ROSS® ANSI valves W70 Series are base mounted spool and sleeve valves that conform to the American National Standards Institute (ANSI) standards for valve-to-base interface configurations, including plug-and-socket electrical connections between valve and base.

These ANSI Size 1, 2.5, 4, 10, and 20 valves are available as, 2- and 3-position, 5-ported 4-way solenoid pilot or pressure controlled valves with either internal or external pilot supply. The spool and sleeve design means there are no seals to wear out.



Illustration examples.

VALVE FEATURES

Spool Design	Spool and Sleeve construction for high dirt tolerance
Mounting Options	Individual sub-base or manifold base mounting
Pilot Supply	Internal or external; suitable for vacuum service (with external pilot supply)
Pilot Operation	Provides high shifting force with low power consumption

Actuation	ANSI Size	Available Inlet Port Sizes							Functions									Maximum Flow C _v	Page	
		1/4	3/8	1/2	3/4	1	1-1/4	1-1/2	5/2		5/3			5/2		5/3				
									Single	Double	Power Center	Closed Center	Open Center	Direct		Double Direct				
														Single	Double	Power Center	Closed Center			Open Center
Solenoid Control	1	●	●					●	●	●	●	●	●	●	●	●	●	●	1.0	4 – 15
	2.5		●	●				●	●	●	●	●	●	●		●	●	2.5		
	4			●	●			●	●	●	●	●	●	●		●	●	4.2		
	10				●	●	●	●	●	●	●							10.0		
	20						●	●	●	●	●							22.0		
Pressure Control	1	●	●					●	●	●	●	●			—			1.0	16 – 21	
	2.5		●	●				●	●		●	●			—			2.5		
	4			●	●			●	●		●	●			—			4.2		
	10				●	●	●	●	●		●	●			—			10.0		
	20						●	●	●	●	●				—			22.0		
Sub-Bases																			32 – 39	
Manifold Bases																			40 – 41	
Accessories and Options																			44	

STANDARD SPECIFICATIONS

GENERAL	Function	5/2 and 5/3 Valve
	Construction Design	Spool and Sleeve
	Actuation	Electrical – Solenoid Pilot Controlled
		Pneumatic – Pressure Controlled
	Mounting	Sub-Base or Manifold
	Connection	Threaded; G, NPT
Manual Override	Flush; rubber, non-locking	

OPERATING CONDITIONS	Temperature	Solenoid Pilot Controlled	Ambient	40° to 120°F (4° to 50°C)
			Media	40° to 175°F (4° to 80°C)
		Pressure Controlled	Ambient	40° to 175°F (4° to 80°C)
			Media	
	Flow Media	Filtered air		
	Operating Pressure	Vacuum to 150 psig (Vacuum to 10 bar)		
	Pilot Supply Pressure	ANSI Size 1 & 20	Minimum 30 psig (2 bar)	
		ANSI Size 2.5, 4, 10	Minimum 15 psig (1 bar)	
External Pilot Supply	Must be equal to or greater than inlet pressure			

ELECTRICAL DATA FOR SOLENOID PILOT CONTROLLED VALVES	Solenoids	Control	ANSI Size	Power Consumption	Operating Voltage (each solenoid)
		Solenoid Pilot	1	24 volts DC	5 watts
				100-110 volts AC, 50 Hz	10 VA inrush, 24 VA holding
				100-130 volts AC, 60 Hz	
				230-240 volts AC, 60 Hz	
			2.5, 4, 10, & 20	24 volts DC	14 watts
				100-110 volts AC, 50 Hz	87 VA inrush, 55 VA holding
		Direct Solenoid	1	100-130 volts AC, 60 Hz	
				230-240 volts AC, 60 Hz	
				24 volts DC	20 watts
2.5 & 4	110-120 volts AC, 50/60 Hz		140 VA inrush, 30 VA holding		
	230-240 volts AC, 60 Hz				
	24 volts DC		20 watts		
Rated for continuous duty					
ANSI Size 4, 10, & 20		Indicator Light – One per solenoid			

CONSTRUCTION MATERIAL	Valve Body	Cast Aluminum
	Spool	Stainless Steel
	Seals	Buna-N

IMPORTANT NOTE: Please read carefully and thoroughly all of the CAUTIONS, WARNINGS on the inside back cover.

PRODUCT CREDENTIALS

CSA Certificate of Compliance 	CE Declaration of Conformity 	EAC Declaration of Conformity 	CRN Certification Available for appropriately tested valves
---	--	---	---

Ordering Information

5/2 Single Solenoid Pilot Controlled Valves

SINGLE SOLENOID PILOT CONTROLLED VALVES

5-Way 2-Position Valves

Size		Valve Model Number*		
		Voltage		
ANSI	Port	24 V DC	110-120 V AC	230 V AC
1	1/4 – 3/8	W7076B2331W	W7076B2331Z	W7076B2331Y
2.5	3/8 – 1/2	W7076A3331W	W7076A3331Z	W7076A3331Y
4	3/8 – 3/4	W7076D4331W	W7076D4331Z	W7076D4331Y
10	3/4 – 1-1/4	W7076C6331W	W7076C6331Z	W7076C6331Y
20	1-1/4 – 1-1/2	W7076C8331W	W7076C8331Z	W7076C8331Y

For other voltages, consult ROSS.

* Sub-bases and manifold bases ordered separately. Please see Sub-Bases and Manifolds section.

Size		Flow C_v	Average Response Constants*			Weight lb (kg)
Body	Port 1		1-2	M	F	
		1-2			2-3	
1	1/4 – 3/8	1.0	20	3.6	4.9	3.0 (1.4)
2.5	3/8 – 1/2	2.5	17	1.6	2.7	3.0 (1.4)
4	3/8 – 3/4	4.2	20	0.6	0.6	5.3 (2.4)
10	3/4 – 1-1/4	10	30	0.3	0.3	7.3 (3.3)
20	1-1/4 – 1-1/2	22	50	0.1	0.2	14.5 (6.5)

Valve Response Time – Response Time (msec) = $M + (F \cdot V)$. This is the average time required to fill a volume V (cubic inches) to 90% of supply pressure or to exhaust it to 10% of supply pressure. M and F values are shown above.

Valve Schematic

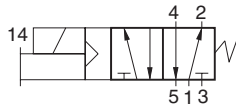

5/2 Single Solenoid Pilot Controlled Valves

DIMENSIONS

Inches (mm)

ANSI Size 1

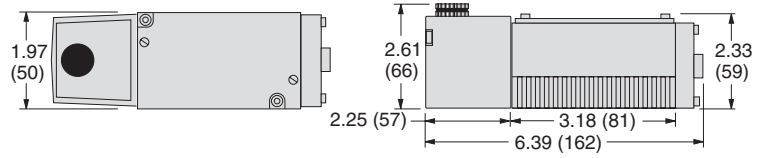

ANSI Size 2.5

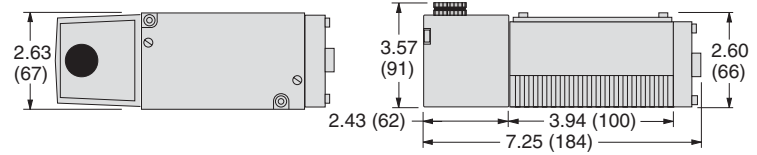

ANSI Size 4

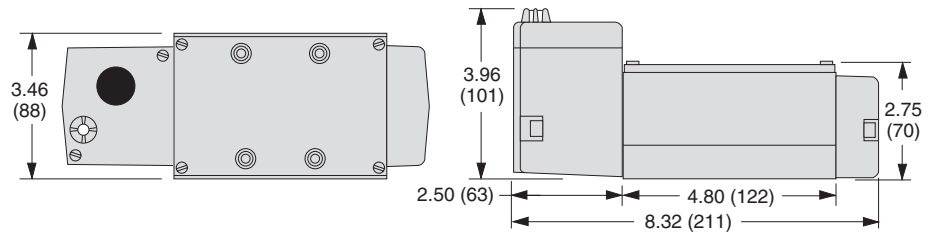

ANSI Size 10

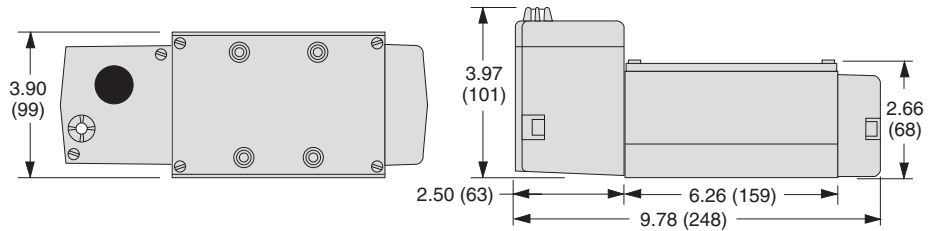

ANSI Size 20

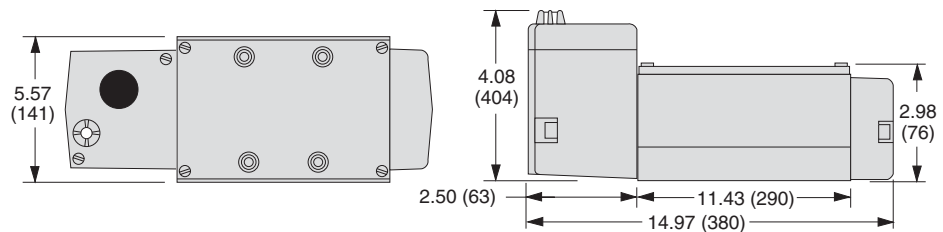

For additional information, and to assist you with piping and connectivity designs, our products are available in downloadable 2D drawings and 3D CAD models in a wide range of options including native formats. Please visit www.rosscontrols.com.

Ordering Information

5/2 Double Solenoid Pilot Controlled Valves

DOUBLE SOLENOID PILOT CONTROLLED VALVES

5-Way 2-Position Valves

Size		Valve Model Number*		
		Voltage		
ANSI	Port	24 V DC	110-120 V AC	230 V AC
1	1/4 – 3/8	W7076B2332W	W7076B2332Z	W7076B2332Y
2.5	3/8 – 1/2	W7076A3332W	W7076A3332Z	W7076A3332Y
4	3/8 – 3/4	W7076D4332W	W7076D4332Z	W7076D4332Y
10	3/4 – 1-1/4	W7076C6332W	W7076C6332Z	W7076C6332Y
20	1-1/4 – 1-1/2	W7076C8332W	W7076C8332Z	W7076C8332Y

For other voltages, consult ROSS.

* Sub-bases and manifold bases ordered separately. Please see Sub-Bases and Manifolds section.

Size		Flow C_v	Average Response Constants*			Weight lb (kg)
Body	Port 1		1-2	F		
		M		1-2	2-3	
1	1/4 – 3/8	1.0	20	3.6	4.9	4.0 (1.8)
2.5	3/8 – 1/2	2.5	17	1.6	2.7	4.0 (1.8)
4	3/8 – 3/4	4.2	20	0.6	0.6	6.5 (2.9)
10	3/4 – 1-1/4	10	30	0.3	0.3	9.0 (4.1)
20	1-1/4 – 1-1/2	22	50	0.1	0.2	15.8 (6.8)

Valve Response Time – Response Time (msec) = $M + (F \cdot V)$. This is the average time required to fill a volume V (cubic inches) to 90% of supply pressure or to exhaust it to 10% of supply pressure. M and F values are shown above.

Valve Schematic

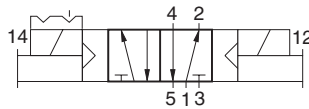

5/2 Double Solenoid Pilot Controlled Valves

DIMENSIONS

Inches (mm)

ANSI Size 1

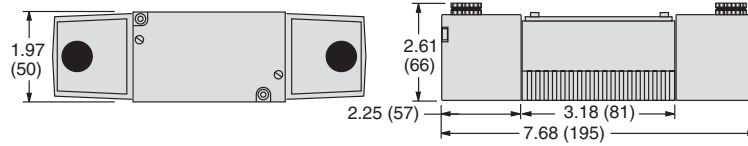

ANSI Size 2.5

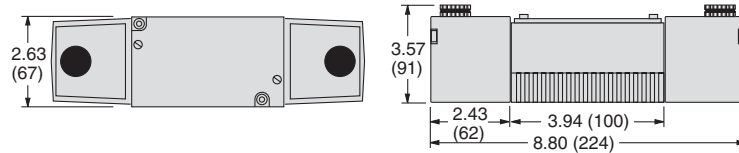

ANSI Size 4

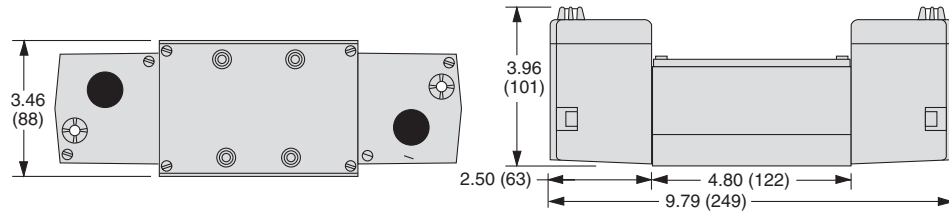

ANSI Size 10

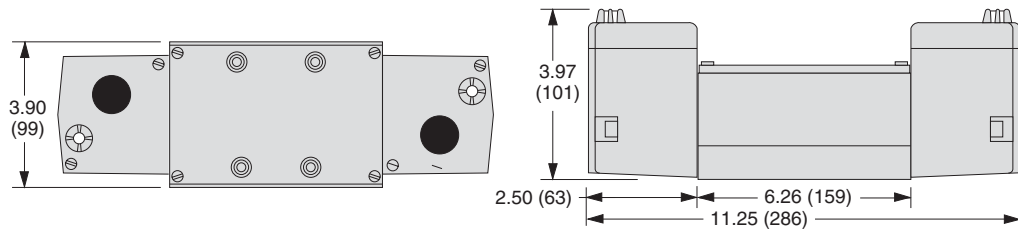

ANSI Size 20

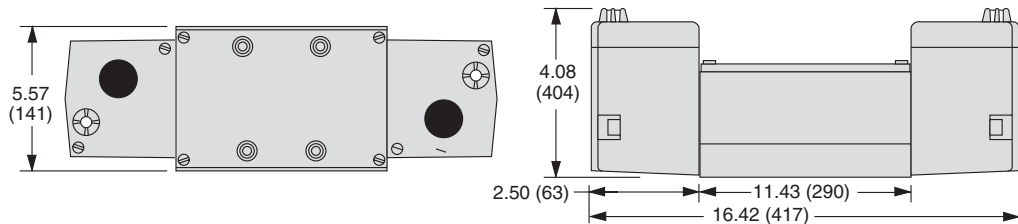

For additional information, and to assist you with piping and connectivity designs, our products are available in downloadable 2D drawings and 3D CAD models in a wide range of options including native formats. Please visit www.rosscontrols.com.

Ordering Information

5/3 Double Solenoid Pilot Controlled Valves

DOUBLE SOLENOID PILOT CONTROLLED VALVES

5-Way 3-Position Valves

Center Position	Size		Valve Model Number*		
			Voltage		
	ANSI	Port	24 V DC	110-120 V AC	230 V AC
Power Center	1	1/4 – 3/8	W7077B2906W	W7077B2906Z	W7077B2906Y
	2.5	3/8 – 1/2	W7077A3904W	W7077A3904Z	W7077A3904Y
	4	3/8 – 3/4	W7077C4939W	W7077C4939Z	W7077C4939Y
	10	3/4 – 1-1/4	W7077A6920W	W7077A6920Z	W7077A6920Y
	20	1-1/4 – 1-1/2	W7077A8901W	W7077A8901Z	W7077A8901Y
Closed Center	1	1/4 – 3/8	W7077B2331W	W7077B2331Z	W7077B2331Y
	2.5	3/8 – 1/2	W7077A3331W	W7077A3331Z	W7077A3331Y
	4	3/8 – 3/4	W7077D4331W	W7077D4331Z	W7077D4331Y
	10	3/4 – 1-1/4	W7077C6331W	W7077C6331Z	W7077C6331Y
	20	1-1/4 – 1-1/2	W7077C8331W	W7077C8331Z	W7077C8331Y
Open Center	1	1/4 – 3/8	W7077B2332W	W7077B2332Z	W7077B2332Y
	2.5	3/8 – 1/2	W7077A3332W	W7077A3332Z	W7077A3332Y
	4	3/8 – 3/4	W7077D4332W	W7077D4332Z	W7077D4332Y
	10	3/4 – 1-1/4	W7077C6332W	W7077C6332Z	W7077C6332Y
	20	1-1/4 – 1-1/2	W7077C8332W	W7077C8332Z	W7077C8332Y

For other voltages, consult ROSS.

* Sub-bases and manifold bases ordered separately. Please see Sub-Bases and Manifolds section.

Size		Flow C _v	Average Response Constants*			Weight lb (kg)
Body	Port 1		1-2	F		
		M		1-2	2-3	
1	1/4 – 3/8	1.0	20	3.6	4.9	4.0 (1.8)
2.5	3/8 – 1/2	2.5	17	1.6	2.7	4.0 (1.8)
4	3/8 – 3/4	4.2	20	0.6	0.6	6.5 (2.9)
10	3/4 – 1-1/4	10	30	0.3	0.3	8.5 (3.8)
20	1-1/4 – 1-1/2	22	50	0.1	0.2	15.3 (6.9)

Valve Response Time – Response Time (msec) = M + (F • V). This is the average time required to fill a volume V (cubic inches) to 90% of supply pressure or to exhaust it to 10% of supply pressure. M and F values are shown above.

Valve Schematics

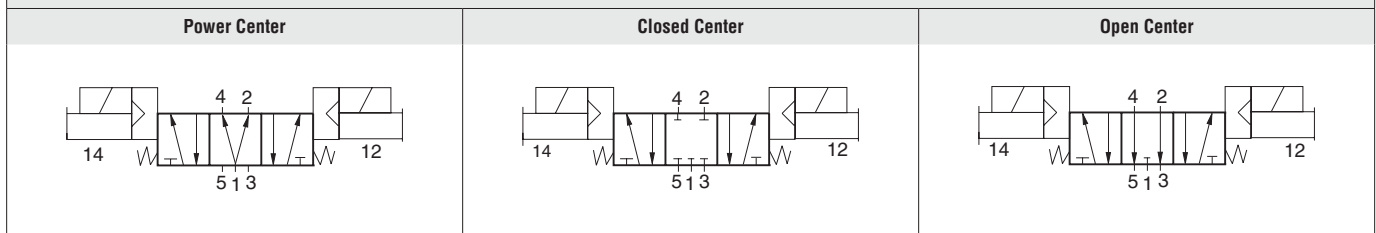

5/3 Double Solenoid Pilot Controlled Valves

DIMENSIONS

Inches (mm)

ANSI Size 1

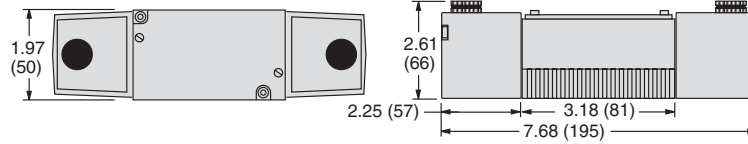

ANSI Size 2.5

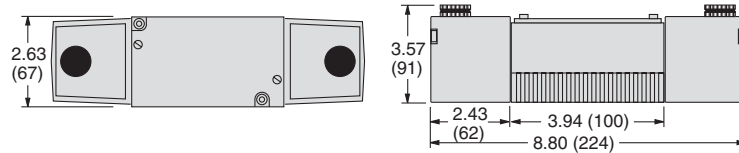

ANSI Size 4

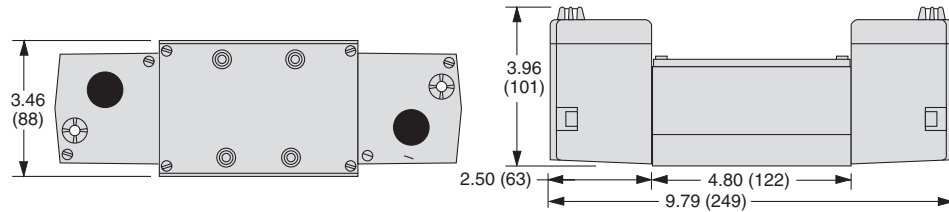

ANSI Size 10

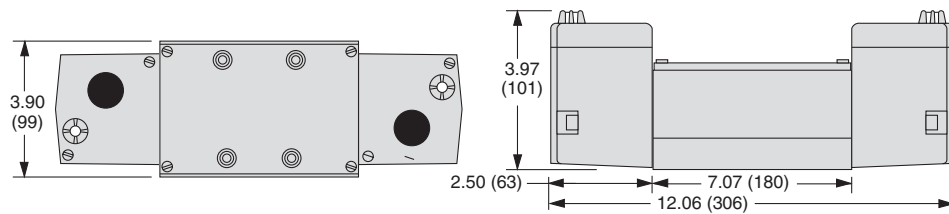

ANSI Size 20

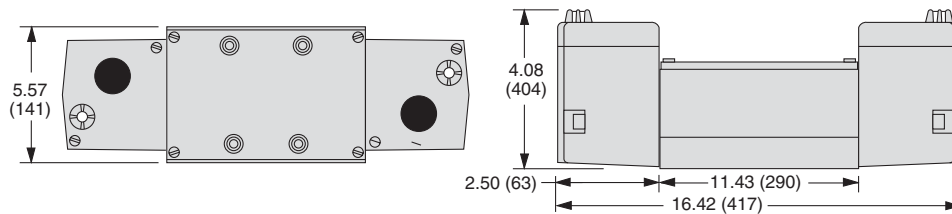

For additional information, and to assist you with piping and connectivity designs, our products are available in downloadable 2D drawings and 3D CAD models in a wide range of options including native formats. Please visit www.rosscontrols.com.

Ordering Information

5/2 Direct Single Solenoid Pilot Controlled Valves

DIRECT SOLENOID PILOT CONTROLLED VALVES

5-Way 2-Position Valves

Size		Valve Model Number*		
		Voltage		
ANSI	Port	24 V DC	110-120 V AC	230 V AC
1	1/4 – 3/8	W7016B2331W	W7016B2331Z	W7016B2331Y
2.5	3/8 – 1/2	–	W7016A3331Z	W7016A3331Y
4	3/8 – 3/4	–	W7016C4331Z	W7016C4331Y

For other voltages, consult ROSS.

* Sub-bases and manifold bases ordered separately. Please see Sub-Bases and Manifolds section.

Size		Flow C_v	Average Response Constants*			Weight lb (kg)
Body	Port 1		1-2	F		
		M		1-2	2-3	
1	1/4 – 3/8	1.0	20	3.6	4.9	3.5 (1.6)
2.5	3/8 – 1/2	2.5	17	1.6	2.7	3.3 (1.5)
4	3/8 – 3/4	4.2	20	0.6	0.6	4.3 (1.9)

Valve Response Time – Response Time (msec) = $M + (F \cdot V)$. This is the average time required to fill a volume V (cubic inches) to 90% of supply pressure or to exhaust it to 10% of supply pressure. M and F values are shown above.

Valve Schematic

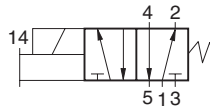

5/2 Direct Single Solenoid Pilot Controlled Valves

DIMENSIONS

Inches (mm)

ANSI Size 1

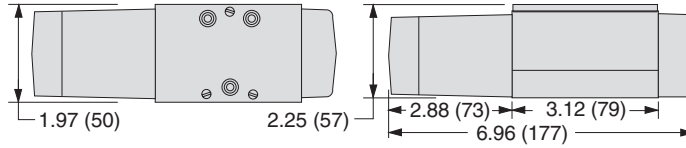

ANSI Size 2.5

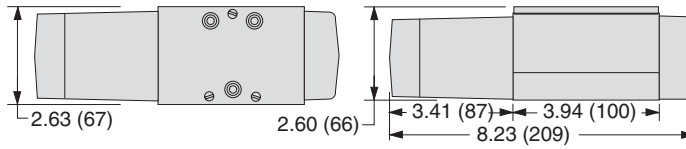

ANSI Size 4

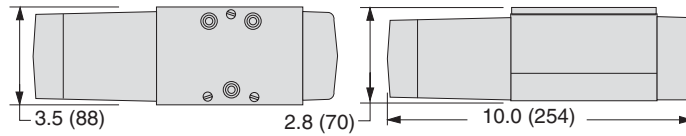

For additional information, and to assist you with piping and connectivity designs, our products are available in downloadable 2D drawings and 3D CAD models in a wide range of options including native formats. Please visit www.rosscontrols.com.

Ordering Information

5/2 Direct Double Solenoid Pilot Controlled Valves

DIRECT SOLENOID PILOT CONTROLLED VALVES

5-Way 2-Position Valves

Size		Valve Model Number*		
		Voltage		
ANSI	Port	24 V DC	110-120 V AC	230 V AC
1	1/4 – 3/8	W7016B2332W	W7016B2332Z	W7016B2332Y
2.5	3/8 – 1/2	–	W7016A3332Z	W7016A3332Y
4	3/8 – 3/4	–	W7016C4332Z	W7016C4332Y

For other voltages, consult ROSS.

* Sub-bases and manifold bases ordered separately. Please see Sub-Bases and Manifolds section.

Size		Flow C_v	Average Response Constants*			Weight lb (kg)
Body	Port 1		1-2	F		
		M		1-2	2-3	
1	1/4 – 3/8	1.0	20	3.6	4.9	3.5 (1.6)
2.5	3/8 – 1/2	2.5	17	1.6	2.7	3.3 (1.5)
4	3/8 – 3/4	4.2	20	0.6	0.6	4.3 (1.9)

Valve Response Time – Response Time (msec) = $M + (F \cdot V)$. This is the average time required to fill a volume V (cubic inches) to 90% of supply pressure or to exhaust it to 10% of supply pressure. M and F values are shown above.

Valve Schematic

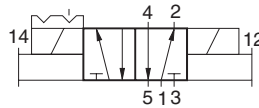

5/2 Direct Double Solenoid Pilot Controlled Valves

DIMENSIONS

Inches (mm)

ANSI Size 1

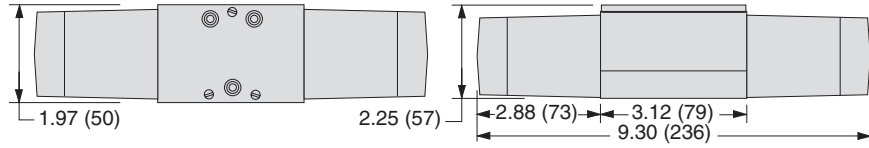

ANSI Size 2.5

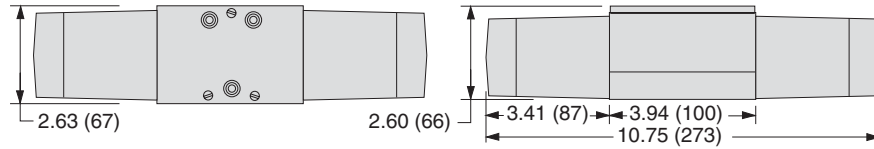

ANSI Size 4

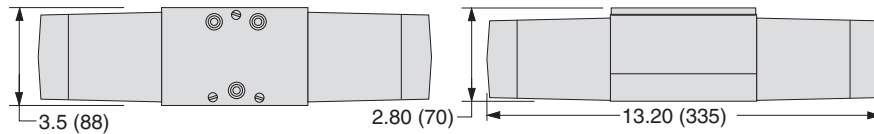

For additional information, and to assist you with piping and connectivity designs, our products are available in downloadable 2D drawings and 3D CAD models in a wide range of options including native formats. Please visit www.rosscontrols.com.

Ordering Information

5/3 Direct Double Solenoid Pilot Controlled Valves

DIRECT SOLENOID PILOT CONTROLLED VALVES

5-Way 3-Position Valves

Center Position	Size		Valve Model Number*		
			Voltage		
	ANSI	Port	24 V DC	110-120 V AC	230 V AC
Power Center	1	1/8 - 3/8	W7017B2905W	W7017B2905Z	W7017B2905Y
Closed Center	1	1/8 - 3/8	W7017B2331W	W7017B2331Z	W7017B2331Y
	2.5	3/8 - 1/2	W7017A3331W	W7017A3331Z	W7017A3331Y
	4	1/2 - 3/4	W7017C4331W	W7017C4331Z	W7017C4331Y
Open Center	1	1/8 - 3/8	W7017B2332W	W7017B2332Z	W7017B2332Y
	2.5	3/8 - 1/2	W7017A3332W	W7017A3332Z	W7017A3332Y
	4	1/2 - 3/4	W7017C4332W	W7017C4332Z	W7017C4332Y

For other voltages, consult ROSS.

* Sub-bases and manifold bases ordered separately. Please see Sub-Bases and Manifolds section.

Size		Flow C_v	Average Response Constants*			Weight lb (kg)
Body	Port 1		M	F		
				1-2	2-3	
1	1/8 - 3/8	1.0	20	3.5	4.9	4.5 (2.0)
2.5	3/8 - 1/2	1.9	10	1.3	1.8	5.0 (2.3)
4	1/2 - 3/4	3.8	-	-	-	5.8 (2.6)

Valve Response Time – Response Time (msec) = $M + (F \cdot V)$. This is the average time required to fill a volume V (cubic inches) to 90% of supply pressure or to exhaust it to 10% of supply pressure. M and F values are shown above.

Valve Schematics

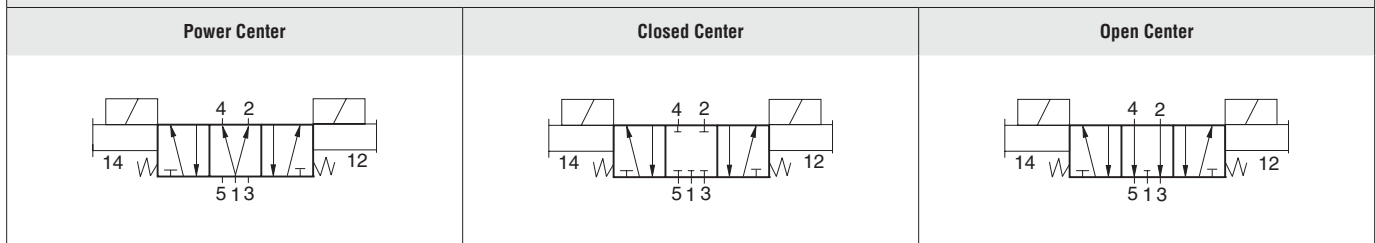

5/3 Direct Double Solenoid Pilot Controlled Valves

DIMENSIONS

Inches (mm)

ANSI Size 1

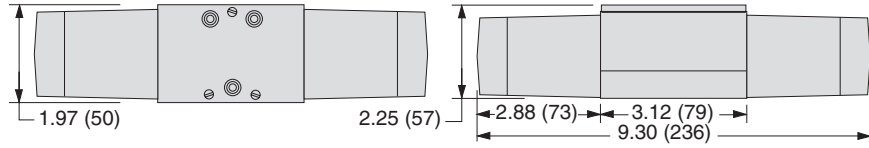

ANSI Size 2.5

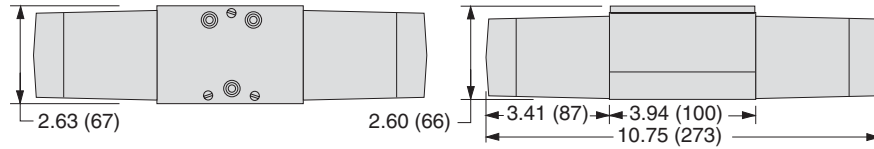

ANSI Size 4

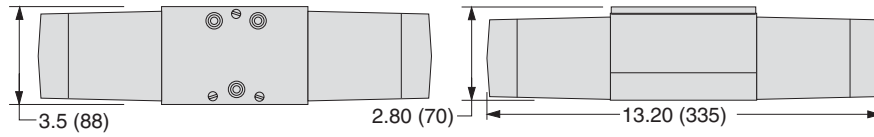

For additional information, and to assist you with piping and connectivity designs, our products are available in downloadable 2D drawings and 3D CAD models in a wide range of options including native formats. Please visit www.rosscontrols.com.

Ordering Information

5/2 Single Pressure Controlled Valves

PRESSURE CONTROLLED VALVES

5-Way 2-Position Valves

Size		Valve Model Number*
ANSI	Port	
1	1/4 – 3/8	W7056B2331
2.5	3/8 – 1/2	W7056A3331
4	3/8 – 3/4	W7056B4331
10	3/4 – 1-1/4	W7056A6331
20	1-1/4 – 1-1/2	W7056A8331

* Sub-bases and manifold bases ordered separately. Please see Sub-Bases and Manifolds section.

Size		Flow C _v	Average Response Constants*			Weight lb (kg)
Body	Port 1		1-2	F		
		M		1-2	2-3	
1	1/4 – 3/8	1.0	20	3.6	4.9	2.5 (1.1)
2.5	3/8 – 1/2	2.5	17	1.5	2.6	2.0 (0.9)
4	3/8 – 3/4	4.2	12	0.6	0.7	4.3 (1.9)
10	3/4 – 1-1/4	10	20	0.3	0.3	6.3 (2.8)
20	1-1/4 – 1-1/2	22	30	0.1	0.2	13.0 (5.9)

Valve Response Time – Response Time (msec) = M + (F • V). This is the average time required to fill a volume V (cubic inches) to 90% of supply pressure or to exhaust it to 10% of supply pressure. M and F values are shown above.

Valve Schematic

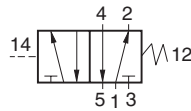

5/2 Single Pressure Controlled Valves

DIMENSIONS

Inches (mm)

ANSI Size 1	
ANSI Size 2.5	
ANSI Size 4	
ANSI Size 10	
ANSI Size 20	
<p>For additional information, and to assist you with piping and connectivity designs, our products are available in downloadable 2D drawings and 3D CAD models in a wide range of options including native formats. Please visit www.rosscontrols.com.</p>	

Ordering Information

5/2 Double Pressure Controlled Valves

PRESSURE CONTROLLED VALVES

5-Way 2-Position Valves

Size		Valve Model Number*
ANSI	Port	
1	1/4 - 3/8	W7056B2332
2.5	3/8 - 1/2	W7056A3332
4	3/8 - 3/4	W7056B4332
10	3/4 - 1 1/4	W7056A6332
20	1 1/4 - 1 1/2	W7056A8332

* Sub-bases and manifold bases ordered separately. Please see Sub-Bases and Manifolds section.

Size		Flow C _v	Average Response Constants*			Weight lb (kg)
Body	Port 1		1-2	F		
		M		1-2	2-3	
1	1/4 - 3/8	1.0	20	3.5	4.9	2.5 (1.1)
2.5	3/8 - 1/2	2.5	17	1.5	2.6	2.0 (0.9)
4	3/8 - 3/4	4.2	12	0.6	0.7	4.3 (1.9)
10	3/4 - 1-1/4	10	20	0.3	0.3	6.3 (2.8)
20	1-1/4 - 1-1/2	22	30	0.1	0.2	13.8 (6.2)

Valve Response Time – Response Time (msec) = M + (F • V). This is the average time required to fill a volume V (cubic inches) to 90% of supply pressure or to exhaust it to 10% of supply pressure. M and F values are shown above.

Valve Schematic

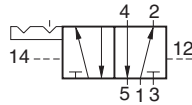

5/2 Double Pressure Controlled Valves

DIMENSIONS

Inches (mm)

ANSI Size 1

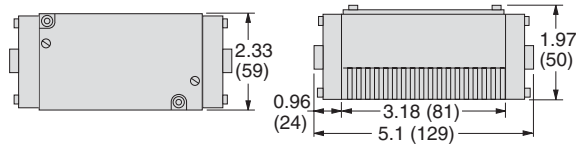

ANSI Size 2.5

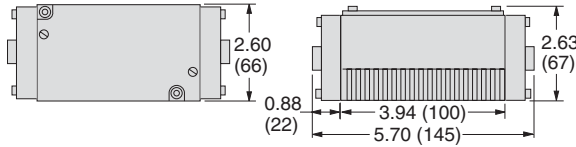

ANSI Size 4

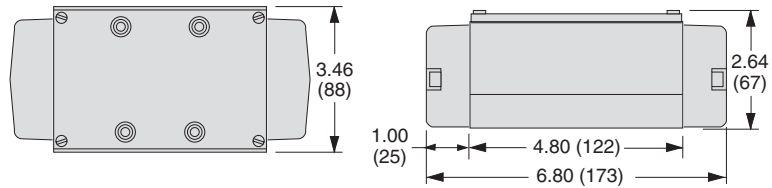

ANSI Size 10

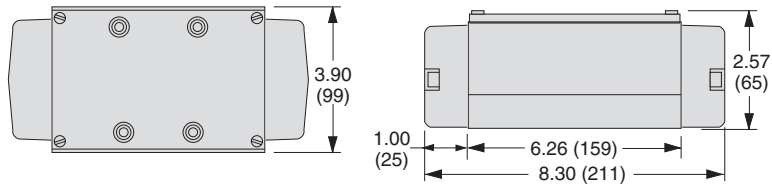

ANSI Size 20

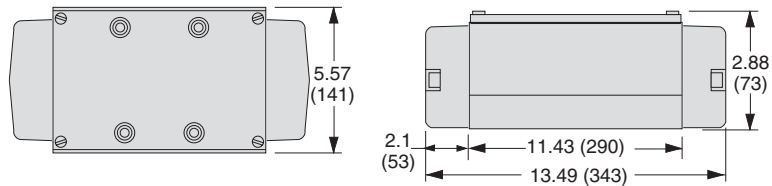

For additional information, and to assist you with piping and connectivity designs, our products are available in downloadable 2D drawings and 3D CAD models in a wide range of options including native formats. Please visit www.rosscontrols.com.

Ordering Information

5/3 Double Pressure Controlled Valves

DOUBLE PRESSURE CONTROLLED VALVES

5-Way 3-Position Valves

Center Position	Size		Valve Model Number*
	ANSI	Port	24 V DC
Power Center	10	3/4 – 1-1/4	W7057A6902
Closed Center	1	1/4 – 3/8	W7057B2331
	2.5	3/8 – 1/2	W7057A3331
	4	3/8 – 3/4	W7057B4331
	10	3/4 – 1-1/4	W7057A6331
	20	1-1/4 – 1-1/2	W7057A8331
Open Center	1	1/4 – 3/8	W7057B2332
	2.5	3/8 – 1/2	W7057A3332
	4	3/8 – 3/4	W7057B4332
	10	3/4 – 1-1/4	W7057A6332
	20	1-1/4 – 1-1/2	W7057A8332

* Sub-bases and manifold bases ordered separately. Please see Sub-Bases and Manifolds section.

Size		Flow C _v	Average Response Constants*			Weight lb (kg)
Body	Port 1		1-2	F		
		M		1-2	2-3	
1	1/4 – 3/8	1.0	20	3.5	4.9	2.5 (1.1)
2.5	3/8 – 1/2	2.5	17	1.5	2.6	2.0 (0.9)
4	3/8 – 3/4	4.2	12	0.6	0.7	4.3 (1.9)
10	3/4 – 1-1/4	10	20	0.3	0.3	6.3 (2.8)
20	1-1/4 – 1-1/2	22	30	0.1	0.2	13.8 (6.2)

Valve Response Time – Response Time (msec) = M + (F • V). This is the average time required to fill a volume V (cubic inches) to 90% of supply pressure or to exhaust it to 10% of supply pressure. M and F values are shown above.

Valve Schematics

Power Center	Closed Center	Open Center

5/3 Double Pressure Controlled Valves

DIMENSIONS

Inches (mm)

ANSI Size 1

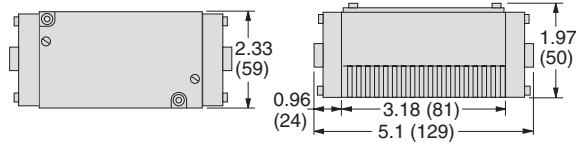

ANSI Size 2.5

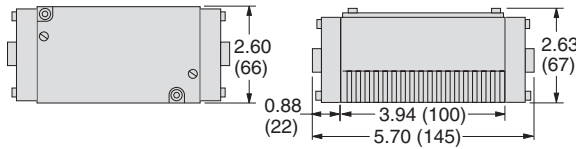

ANSI Size 4

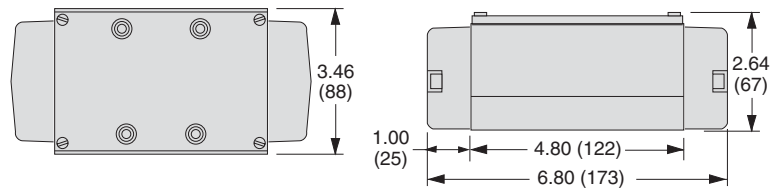

ANSI Size 10

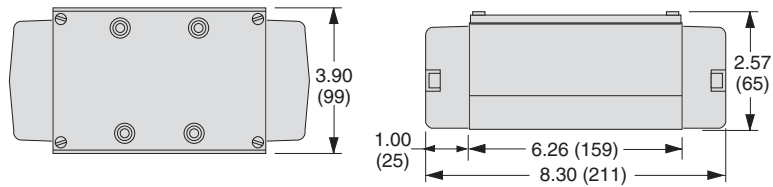

ANSI Size 20

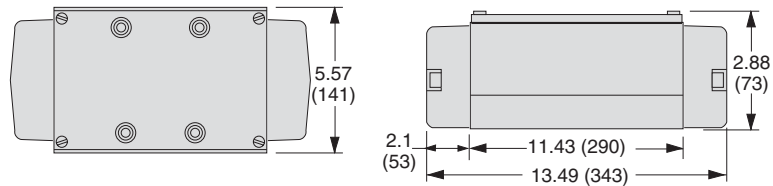

For additional information, and to assist you with piping and connectivity designs, our products are available in downloadable 2D drawings and 3D CAD models in a wide range of options including native formats. Please visit www.rosscontrols.com.

ANSI Valves W74 Series

Product Overview

The ROSS® ANSI Valves W74 Series are base mounted poppet valves that conform to the American National Standards Institute (ANSI) standards for valve-to-base interface configurations, including plug-and-socket electrical connections between valve and base. These ANSI valves are available in Size 1, 2.5, 4, 10, and 20 as standard and high temperature valves, 2- and 3-position, 5-ported 4-way solenoid pilot or pressure controlled valves with either internal or external pilot supply. The poppet design is highly tolerant of contaminated air and are self compensating for wear.

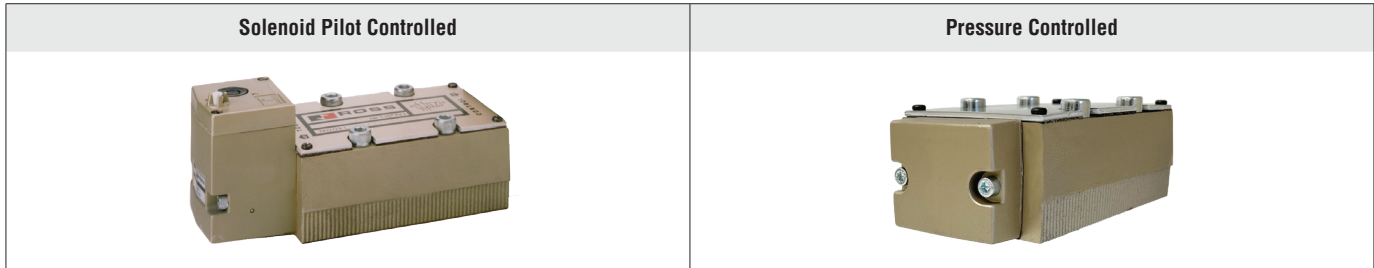

Illustration examples.

VALVE FEATURES

Poppet Design Poppet construction, highly tolerant of contaminated air and self compensating for wear

Mounting Options Individual sub-base or manifold base mounting

Pilot Supply Internal or external; suitable for vacuum service (with external pilot supply)

Pilot Operation Provides high shifting force with low power consumption

Actuation	ANSI Size	Available Inlet Port Sizes							Functions					Maximum Flow C _v	Page
		1/4	3/8	1/2	3/4	1	1-1/4	1-1/2	5/2		5/3				
									Single	Double	Power Center	Closed Center	Open Center		
Solenoid Control	1	●	●						●	●	●	●	●	1.0	24 – 27
	2.5		●	●					●	●	●	●	●	2.5	
	4			●	●				●	●	●	●	●	4.2	
	10				●	●	●		●	●	●	●	●	10.0	
	20						●	●	●	●	●	●	●	22.0	
Pressure Control	1	●	●						●	●	●	●	●	1.0	28 – 31
	2.5		●	●					●	●		●	●	2.5	
	4			●	●				●	●		●	●	4.2	
	10				●	●	●		●	●		●	●	10.0	
	20						●	●	●	●		●	●	22.0	
Sub-Bases													32 – 39		
Manifold Bases													40 – 41		
Accessories and Options													44		

STANDARD SPECIFICATIONS

GENERAL	Function	5/2 and 5/3 Valves
	Construction Design	Poppet
	Actuation	Electrical – Solenoid Pilot Controlled
		Pneumatic – Pressure Controlled
	Mounting	Sub-Base or Manifold
	Connection	Threaded; G, NPT
Manual Override	Flush; rubber, non-locking	

OPERATING CONDITIONS	Temperature	Solenoid Pilot Controlled	Standard Temperature	Ambient	40° to 120°F (5° to 50°C)
				Media	40° to 175°F (5° to 80°C)
			High Temperature	Ambient	40° to 175°F (5° to 80°C)
		Media		40° to 220°F (5° to 105°C)	
		<i>For other temperature ranges, consult ROSS.</i>			
		Pressure Controlled	Standard Temperature	Ambient	0° to 300°F (-17° to 150°C)
	Media			0° to 300°F (-17° to 150°C)	
	High Temperature		Ambient	-40° to 175°F (-40° to 80°C)	
			Media	-40° to 175°F (-40° to 80°C)	
	<i>For other temperature ranges, consult ROSS.</i>				
Flow Media	Filtered air				
Operating Pressure	Vacuum to 150 psig (Vacuum to 10 bar)				
Pilot Supply Pressure	Minimum 30 psig (2 bar)				
External Pilot Supply	Must be equal to or greater than inlet pressure				

ELECTRICAL DATA FOR SOLENOID PILOT VALVES	Solenoids	ANSI Size	Power Consumption	Operating Voltage (each solenoid)
		1	24 volts DC	5 watts
			100-110 volts AC, 50 Hz	10 VA inrush, 24 VA holding
			100-120 volts AC, 60 Hz	
			230-240 volts AC, 60 Hz	
		2.5, 4, 10, & 20	24 volts DC	15 watts
			110-120 volts AC, 50/60 Hz	87 VA inrush, 55 VA holding
230-240 volts AC, 60 Hz				
Rated for continuous duty				
ANSI Size 4, 10, & 20	Indicator Light – One per solenoid			

CONSTRUCTION MATERIAL	Valve Body	Cast Aluminum
	Poppet	Rubber Coated Aluminum & Stainless Steel
	Seals	Buna-N

IMPORTANT NOTE: Please read carefully and thoroughly all of the CAUTIONS, WARNINGS on the inside back cover.

PRODUCT CREDENTIALS

CSA Certificate of Compliance	Declaration of Conformity		CRN Certification
	CE	EAC	Available for appropriately tested valves

Ordering Information

5/2 Single Solenoid Pilot Controlled Valves

SINGLE SOLENOID PILOT CONTROLLED VALVES

5-Way 2-Position Valves

Size		STANDARD TEMPERATURE			HIGH TEMPERATURE		
		Valve Model Number*			Valve Model Number*		
		Voltage			Voltage		
ANSI	Port	24 V DC	110-120 V AC	230 V AC	24 V DC	110-120 V AC	230 V AC
1	1/4 – 3/8	W7476B2331W	W7476B2331Z	W7476B2331Y	W7476B2336W	W7476B2336Z	W7476B2336Y
2.5	3/8 – 1/2	W7476A3331W	W7476A3331Z	W7476A3331Y	W7476A3336W	W7476A3336Z	W7476A3336Y
4	3/8 – 3/4	W7476D4331W	W7476D4331Z	W7476D4331Y	W7476D4336W	W7476D4336Z	W7476D4336Y
10	3/4 – 1-1/4	W7476A6331W	W7476A6331Z	W7476A6331Y	W7476A6336W	W7476A6336Z	W7476A6336Y
20	1-1/4 – 1-1/2	W7476A8331W	W7476A8331Z	W7476A8331Y	W7476A8336W	W7476A8336Z	W7476A8336Y

For other voltages, consult ROSS.

* Sub-bases and manifold bases ordered separately. Please see Sub-Bases and Manifolds section.

Size		Flow C _v	Average Response Constants*			Weight lb (kg)
Body	Port 1	1-2	M	F		
				1-2	2-3	
1	1/4 – 3/8	0.9	30	2.7	5.6	3.0 (1.4)
2.5	3/8 – 1/2	2.0	25	1.5	2.9	3.0 (1.4)
4	3/8 – 3/4	4.2	27	0.6	1.0	5.0 (2.3)
10	3/4 – 1-1/4	11	30	0.3	0.5	6.1 (2.8)
20	1-1/4 – 1-1/2	22	50	0.1	0.2	18.5 (8.3)

Valve Response Time – Response Time (msec) = M + (F • V). This is the average time required to fill a volume V (cubic inches) to 90% of supply pressure or to exhaust it to 10% of supply pressure. M and F values are shown above.

Valve Schematic

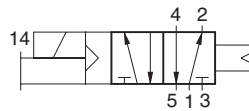

5/2 Single Solenoid Pilot Controlled Valves

DIMENSIONS

Inches (mm)

ANSI Size 1

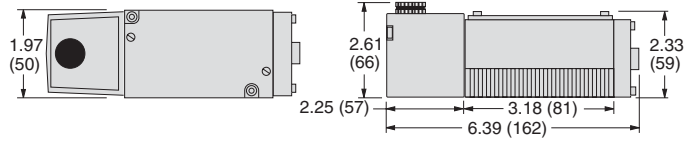

ANSI Size 2.5

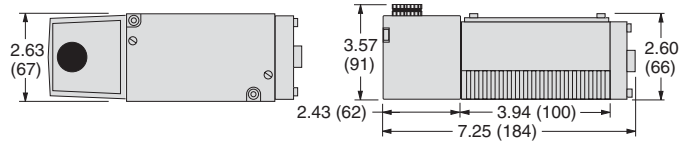

ANSI Size 4

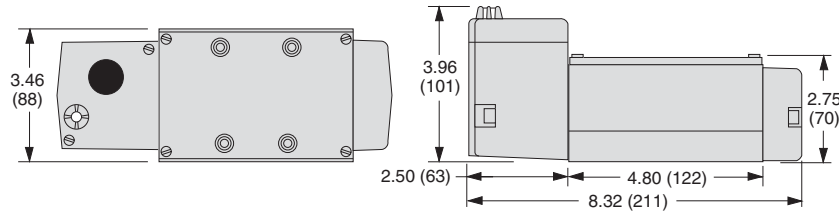

ANSI Size 10

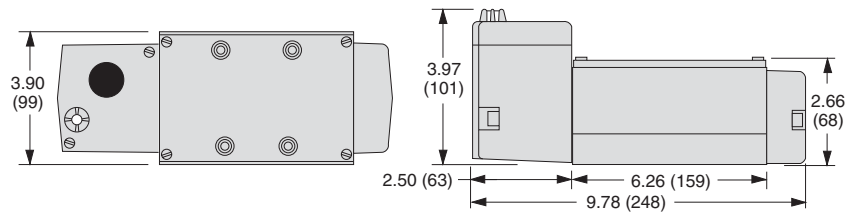

ANSI Size 20

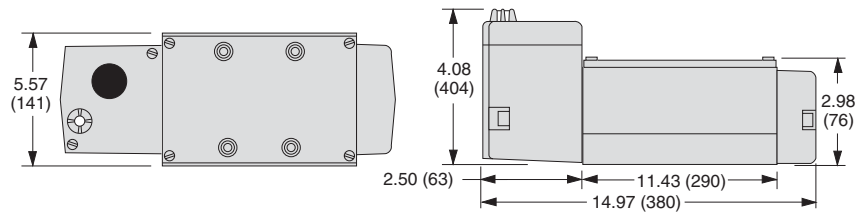

For additional information, and to assist you with piping and connectivity designs, our products are available in downloadable 2D drawings and 3D CAD models in a wide range of options including native formats. Please visit www.rosscontrols.com.

Ordering Information

5/2 Double Solenoid Pilot Controlled Valves

DOUBLE SOLENOID PILOT CONTROLLED VALVES

5-Way 2-Position Valves

Size		STANDARD TEMPERATURE			HIGH TEMPERATURE		
		Valve Model Number*			Valve Model Number*		
ANSI	Port	24 V DC	110-120 V AC	230 V AC	24 V DC	110-120 V AC	230 V AC
1	1/4 – 3/8	W7476B2332W	W7476B2332Z	W7476B2332Y	W7476B2337W	W7476B2337Z	W7476B2337Y
2.5	3/8 – 1/2	W7476A3332W	W7476A3332Z	W7476A3332Y	W7476A3337W	W7476A3337Z	W7476A3337Y
4	3/8 – 3/4	W7476D4332W	W7476D4332Z	W7476D4332Y	W7476D4337W	W7476D4337Z	W7476D4337Y
10	3/4 – 1-1/4	W7476A6332W	W7476A6332Z	W7476A6332Y	W7476A6337W	W7476A6337Z	W7476A6337Y
20	1-1/4 – 1-1/2	W7476A8332W	W7476A8332Z	W7476A8332Y	W7476A8337W	W7476A8337Z	W7476A8337Y

For other voltages, consult ROSS.

* Sub-bases and manifold bases ordered separately. Please see Sub-Bases and Manifolds section.

Size		Flow C_v	Average Response Constants*			Weight lb (kg)
Body	Port 1		1-2	M	F	
		1-2			2-3	
1	1/4 – 3/8	0.9	30	2.7	5.6	3.0 (1.4)
2.5	3/8 – 1/2	2.0	25	1.5	2.9	3.0 (1.4)
4	3/8 – 3/4	4.2	27	0.6	1.0	5.0 (2.3)
10	3/4 – 1-1/4	11	30	0.3	0.5	6.1 (2.8)
20	1-1/4 – 1-1/2	22	50	0.1	0.2	18.5 (8.3)

Valve Response Time – Response Time (msec) = $M + (F \cdot V)$. This is the average time required to fill a volume V (cubic inches) to 90% of supply pressure or to exhaust it to 10% of supply pressure. M and F values are shown above.

Valve Schematic

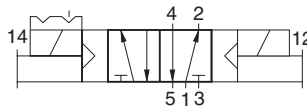

5/2 Double Solenoid Pilot Controlled Valves

DIMENSIONS

Inches (mm)

ANSI Size 1

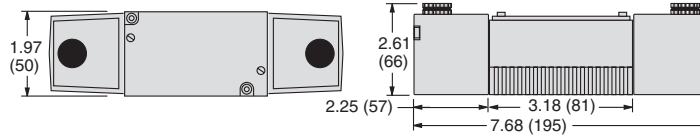

ANSI Size 2.5

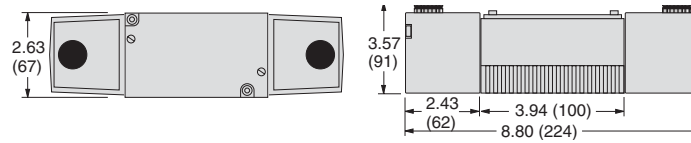

ANSI Size 4

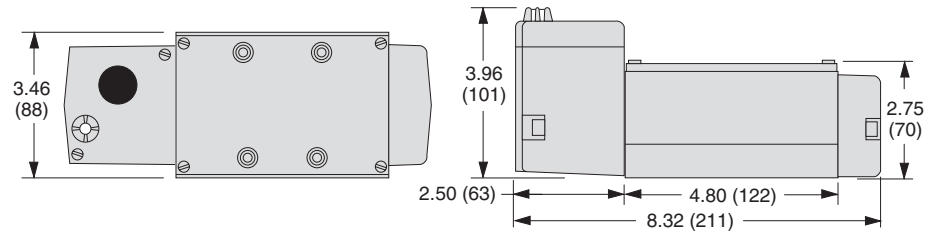

ANSI Size 10

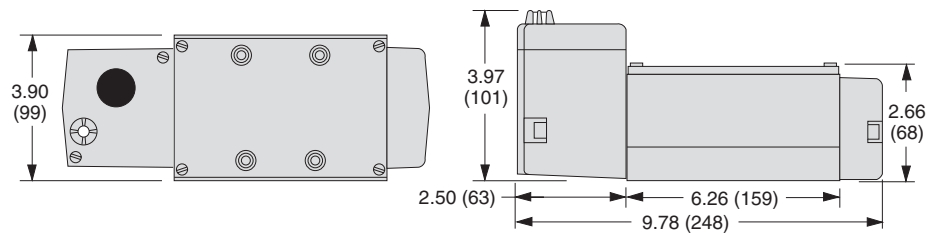

ANSI Size 20

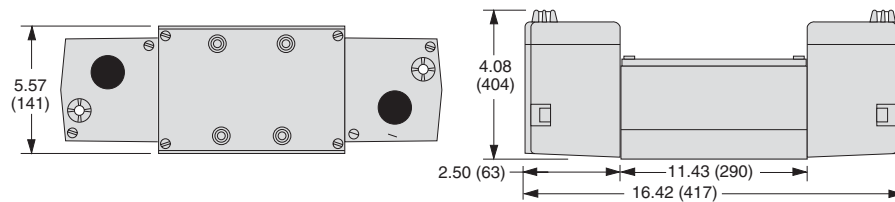

For additional information, and to assist you with piping and connectivity designs, our products are available in downloadable 2D drawings and 3D CAD models in a wide range of options including native formats. Please visit www.rosscontrols.com.

Ordering Information

5/2 Single Pressure Controlled Valves

SINGLE PRESSURE CONTROLLED VALVES

5-Way 2-Position Valves

Size		STANDARD TEMPERATURE	HIGH TEMPERATURE
ANSI	Port	Valve Model Number*	Valve Model Number*
1	1/4 – 3/8	W7456B2331	W7456B2336
2.5	3/8 – 1/2	W7456A3331	W7456A3336
4	3/8 – 3/4	W7456B4331	W7456B4336
10	3/4 – 1-1/4	W7456A6331	W7456A6336
20	1-1/4 – 1-1/2	W7456A8331	W7456A8336

* Sub-bases and manifold bases ordered separately. Please see Sub-Bases and Manifolds section.

Size		Flow C _v	Average Response Constants*			Weight lb (kg)
Body	Port 1	1-2	M	F		
				1-2	2-3	
1	1/4 – 3/8	1.0	20	3.6	4.9	2.5 (1.1)
2.5	3/8 – 1/2	2.5	17	1.5	2.6	2.0 (0.9)
4	3/8 – 3/4	4.2	12	0.6	0.7	4.3 (1.9)
10	3/4 – 1-1/4	10	20	0.3	0.3	6.3 (2.8)
20	1-1/4 – 1-1/2	22	30	0.1	0.2	13.0 (5.9)

Valve Response Time – Response Time (msec) = $M + (F \cdot V)$. This is the average time required to fill a volume V (cubic inches) to 90% of supply pressure or to exhaust it to 10% of supply pressure. M and F values are shown above.

Valve Schematic

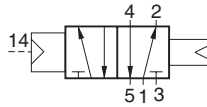

5/2 Single Pressure Controlled Valves

DIMENSIONS

Inches (mm)

ANSI Size 1

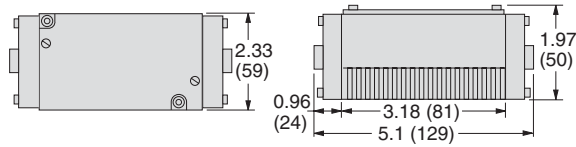

ANSI Size 2.5

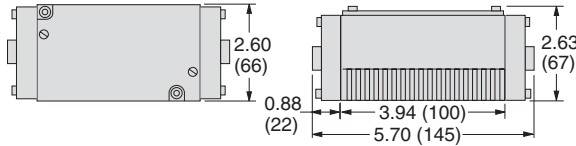

ANSI Size 4

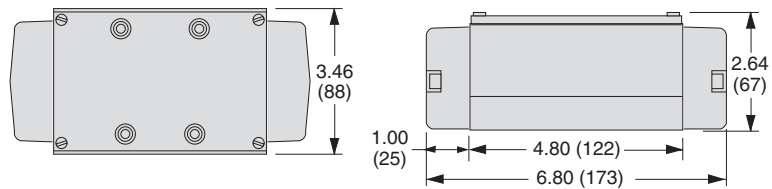

ANSI Size 10

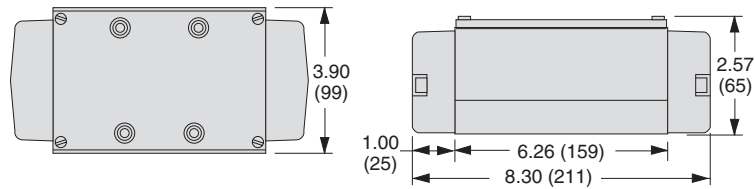

ANSI Size 20

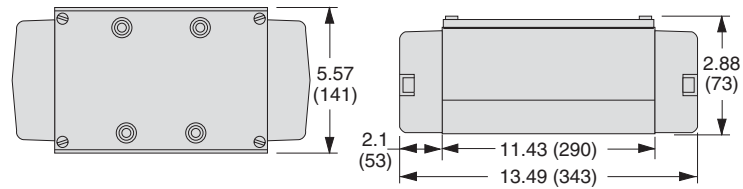

For additional information, and to assist you with piping and connectivity designs, our products are available in downloadable 2D drawings and 3D CAD models in a wide range of options including native formats. Please visit www.rosscontrols.com.

Ordering Information

5/2 Double Pressure Controlled Valves

DOUBLE PRESSURE CONTROLLED VALVES

5-Way 2-Position Valves

Size		STANDARD TEMPERATURE	HIGH TEMPERATURE
ANSI	Port	Valve Model Number*	Valve Model Number*
1	1/4 – 3/8	W7456B2332	W7456B2337
2.5	3/8 – 1/2	W7456A3332	W7456A3337
4	3/8 – 3/4	W7456B4332	W7456B4337
10	3/4 – 1-1/4	W7456A6332	W7456A6337
20	1-1/4 – 1-1/2	W7456A8332	W7456A8337

* Sub-bases and manifold bases ordered separately. Please see Sub-Bases and Manifolds section.

Size		Flow C _v	Average Response Constants*			Weight lb (kg)
Body	Port 1	1-2	M	F		
				1-2	2-3	
1	1/4 – 3/8	0.9	30	2.7	5.6	2.5 (1.1)
2.5	3/8 – 1/2	2.0	25	1.4	2.9	2.0 (0.9)
4	3/8 – 3/4	4.2	16	0.5	1.1	3.3 (1.5)
10	3/4 – 1-1/4	11	14	0.3	0.5	7.3 (3.3)
20	1-1/4 – 1-1/2	22	32	0.1	0.2	17.5 (7.9)

Valve Response Time – Response Time (msec) = M + (F • V). This is the average time required to fill a volume V (cubic inches) to 90% of supply pressure or to exhaust it to 10% of supply pressure. M and F values are shown above.

Valve Schematic

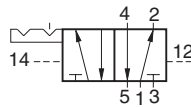

5/2 Double Pressure Controlled Valves

DIMENSIONS

Inches (mm)

ANSI Size 1	
ANSI Size 2.5	
ANSI Size 4	
ANSI Size 10	
ANSI Size 20	

For additional information, and to assist you with piping and connectivity designs, our products are available in downloadable 2D drawings and 3D CAD models in a wide range of options including native formats. Please visit www.rosscontrols.com.

Sub-Bases – Side Ported Ordering Information

For Solenoid Pilot Controlled Valves

SIDE PORTED SUB-BASES

Indicator Lights in Base	ANSI Size	Outlet Port	Model Number		Avg. C _v
			G Thread	NPT Thread	
None	1	1/4	D500B91	500B91	0.9 to 1.0
		3/8	D501B91	501B91	0.9 to 1.0
	2.5	3/8	D474K91	474K91	2.0 to 2.5
		1/2	D475K91	475K91	2.0 to 2.5
	4	3/8	D361B91	361B91	4.2
		1/2	D362B91	362B91	4.2
		3/4	D363B91	363B91	4.2
	10	3/4	D364B91	364B91	10 to 11
		1	D365B91	365B91	10 to 11
		1-1/4	D366B91	366B91	10 to 11
	20	1-1/4	D367B91	367B91	22
		1-1/2	D368B91	368B91	22

Indicator Lights in Base	ANSI Size	Outlet Port	Model Number						Avg. C _v
			G Thread			NPT Thread			
			24 V DC	110-120 V AC	230 V AC	24 V DC	110-120 V AC	230 V AC	
One	1	1/4	D525K91-W	D525K91-Z	D525K91-Y	525K91-W	525K91-Z	525K91-Y	0.9 to 1.0
		3/8	D527K91-W	D527K91-Z	D527K91-Y	527K91-W	527K91-Z	527K91-Y	0.9 to 1.0
	2.5	3/8	D482K91-W	D482K91-Z	D482K91-Y	482K91-W	482K91-Z	482K91-Y	2.0 to 2.5
		1/2	D483K91-W	D483K91-Z	D483K91-Y	483K91-W	483K91-Z	483K91-Y	2.0 to 2.5
Two	1	1/4	D525K91-W	D525K91-Z	D525K91-Y	526K91-W	526K91-Z	526K91-Y	0.9 to 1.0
		3/8	D527K91-W	D527K91-Z	D527K91-Y	528K91-W	528K91-Z	528K91-Y	0.9 to 1.0
	2.5	3/8	D482K91-W	D482K91-Z	D482K91-Y	484K91-W	484K91-Z	484K91-Y	2.0 to 2.5
		1/2	D483K91-W	D483K91-Z	D483K91-Y	485K91-W	485K91-Z	485K91-Y	2.0 to 2.5

For other voltages, consult ROSS.

Sub-base for ANSI Size 4



Illustration example.

For Solenoid Pilot Controlled Valves

DIMENSIONS

Inches (mm)

ANSI Size
1 & 2.5

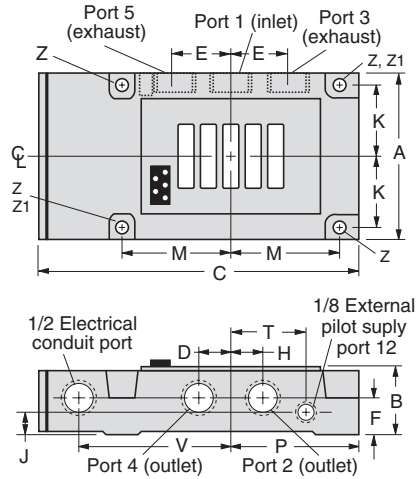

Dimensions inches (mm)					
	ANSI 1	ANSI 2.5	ANSI 4	ANSI 10	ANSI 20
A	2.80 (71)	3.56 (90)	3.36 (85)	5.08 (129)	6.64 (169)
B	1.44 (37)	1.61 (41)	2.64 (67)	3.78 (96)	3.70 (94)
C	6.15 (156)	7.09 (180)	7.21 (183)	10.45 (266)	12.34 (313)
D	0.51 (13)	0.63 (16)	0.75 (19)	1.38 (35)	1.38 (35)
E	0.88 (22)	1.25 (32)	1.50 (38)	2.76 (70)	2.76 (70)
F	0.78 (20)	0.93 (23)	1.23 (31)	1.75 (44)	1.59 (40)
H	0.58 (15)	0.63 (16)	2.21 (56)	3.01 (76)	2.85 (72)
J	0.38 (10)	0.50 (13)	-	-	-
K	1.13 (29)	1.50 (38)	-	2.05 (52)	2.38 (60)
M	1.88 (48)	2.31 (59)	-	4.33 (110)	5.35 (136)
P	2.43 (62)	2.97 (75)	2.86 (73)	4.76 (121)	5.86 (149)
S	-	-	2.36 (60)	-	-
T	1.35 (34)	1.78 (45)	-	-	-
U	-	-	0.83 (21)	1.97 (50)	1.54 (39)
V	2.75 (70)	3.29 (83)	3.07 (78)	4.65 (118)	5.60 (142)
W	-	-	1.23 (31)	2.50 (64)	2.15 (55)
Z	0.27 (7)	-	0.30 (7)	-	-
Z1	-	0.28 (7)	-	0.34 (9)	0.37 (9)

ANSI Size
4, 10, & 20

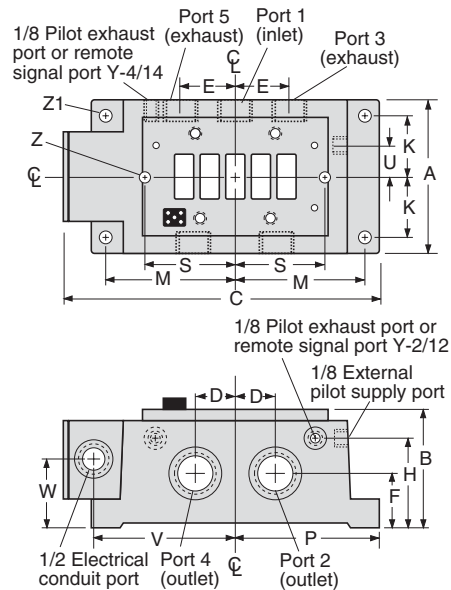

For additional information, and to assist you with piping and connectivity designs, our products are available in downloadable 2D drawings and 3D CAD models in a wide range of options including native formats. Please visit www.rosscontrols.com.

Sub-Bases – Side Ported Ordering Information

For Pressure Controlled Valves

SIDE PORTED SUB-BASES

ANSI Size	Outlet Port	Model Number		Avg. C _v
		G Thread	NPT Thread	
1	1/4	D500B91	500B91	0.9 to 1.0
	3/8	D501B91	501B91	0.9 to 1.0
2.5	3/8	D474K91	474K91	2.0 to 2.5
	1/2	D475K91	475K91	2.0 to 2.5
4	3/8	D361B91	361B91	4.2
	1/2	D362B91	362B91	4.2
	3/4	D363B91	363B91	4.2
10	3/4	D364B91	364B91	10 to 11
	1	D365B91	365B91	10 to 11
	1-1/4	D366B91	366B91	10 to 11
20	1-1/4	D367B91	367B91	22
	1-1/2	D368B91	368B91	22



Illustration example.

For Pressure Controlled Valves

DIMENSIONS

Inches (mm)

ANSI Size
1 & 2.5

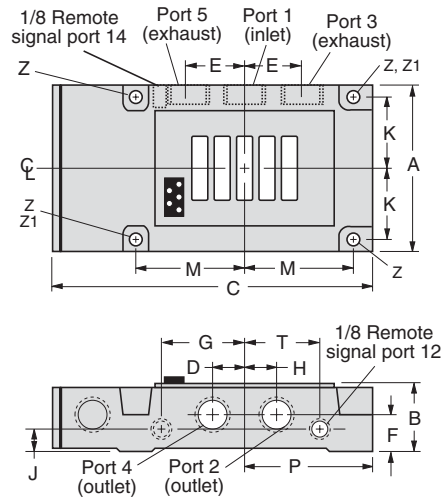

Dimensions inches (mm)					
	ANSI 1	ANSI 2.5	ANSI 4	ANSI 10	ANSI 20
A	2.80 (71)	3.56 (90)	3.36 (85)	5.08 (129)	6.64 (169)
B	1.44 (37)	1.61 (41)	2.64 (67)	3.78 (96)	3.70 (94)
C	6.15 (156)	7.09 (180)	7.21 (183)	10.45 (266)	12.34 (313)
D	0.51 (13)	0.63 (16)	0.75 (19)	1.38 (35)	1.38 (35)
E	0.88 (22)	1.25 (32)	1.50 (38)	2.76 (70)	2.76 (70)
F	0.78 (20)	0.93 (23)	1.23 (31)	1.75 (44)	1.59 (40)
H	0.58 (15)	0.63 (16)	2.21 (56)	3.01 (76)	2.85 (72)
J	0.38 (10)	0.50 (13)	-	-	-
K	1.13 (29)	1.50 (38)	-	2.05 (52)	2.38 (60)
M	1.88 (48)	2.31 (59)	-	4.33 (110)	5.35 (136)
P	2.43 (62)	2.97 (75)	2.86 (73)	4.76 (121)	5.86 (149)
S	-	-	2.36 (60)	-	-
T	1.35 (34)	1.78 (45)	-	-	-
U	-	-	0.83 (21)	1.97 (50)	1.54 (39)
V	-	-	-	-	-
Z	0.27 (7)	-	0.30 (7)	-	-
Z1	-	0.28 (7)	-	0.34 (9)	0.37 (9)

ANSI Size
4, 10, & 20

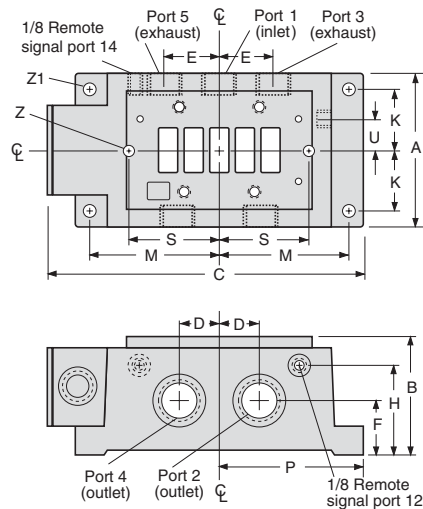

For additional information, and to assist you with piping and connectivity designs, our products are available in downloadable 2D drawings and 3D CAD models in a wide range of options including native formats. Please visit www.rosscontrols.com.

Sub-Bases – Side & Bottom Ported Ordering Information

For Solenoid Pilot or Pressure Controlled Valves

SIDE & BOTTOM PORTED SUB-BASE

Indicator Lights in Base	ANSI Size	Outlet Port	Model Number		Avg. C _v
			G Thread	NPT Thread	
None	1	1/4	D499B91	499B91	0.9 to 1.0
	2.5	3/8	D476K91	476K91	2.0 to 2.5
	4	3/8	D369B91	369B91	4.2
		1/2	D370B91	370B91	4.2
		3/4	D371B91	371B91	4.2

Indicator Lights in Base	ANSI Size	Outlet Port	Model Number						Avg. C _v
			G Thread			NPT Thread			
			24 V DC	110-120 V AC	230 V AC	24 V DC	110-120 V AC	230 V AC	
One	1	1/4	D529K91-W	D529K91-Z	D529K91-Y	529K91-W	529K91-Z	529K91-Y	0.9 to 1.0
	2.5	3/8	D477K91-W	D477K91-Z	D477K91-Y	477K91-W	477K91-Z	477K91-Y	2.0 to 2.5
Two	1	1/4	D530K91-W	D530K91-Z	D530K91-Y	530K91-W	530K91-Z	530K91-Y	0.9 to 1.0
	2.5	3/8	D486K91-W	D486K91-Z	D486K91-Y	486K91-W	486K91-Z	486K91-Y	0.9 to 1.0

For other voltages, consult ROSS.

For Solenoid Pilot Controlled Valves

DIMENSIONS

Inches (mm)

ANSI Size 1 & 2.5

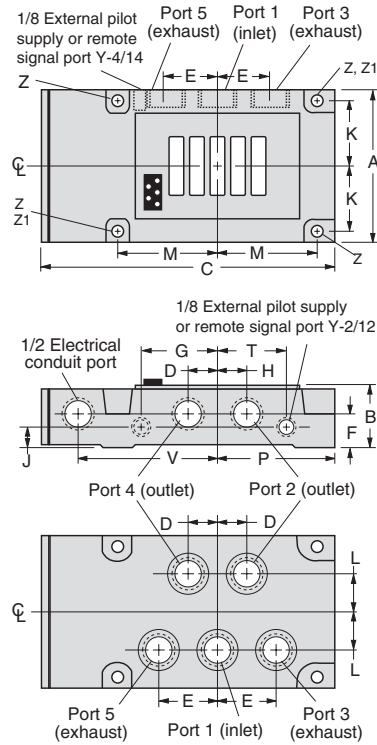

ANSI Size 4

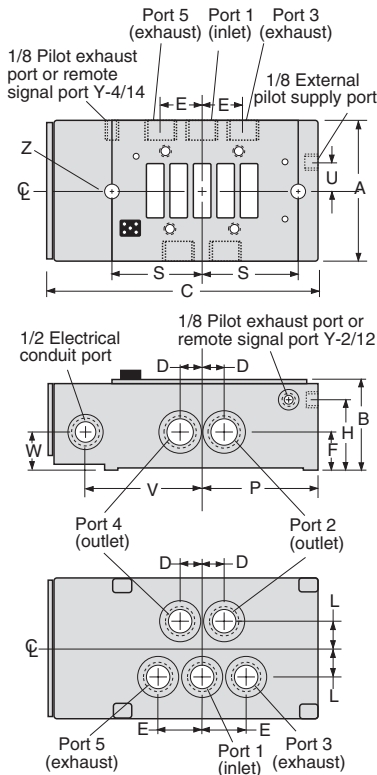

Dimensions inches (mm)			
	ANSI 1	ANSI 2.5	ANSI 4
A	2.80 (71)	3.56 (90)	3.36 (85)
B	1.44 (37)	1.61 (41)	2.64 (67)
C	6.15 (156)	7.09 (180)	7.21 (183)
D	0.51 (13)	0.63 (16)	0.75 (19)
E	0.88 (22)	1.25 (32)	1.50 (38)
F	0.78 (20)	0.93 (23)	1.23 (31)
G	1.46 (37)	2.41 (61)	–
H	0.58 (15)	0.63 (16)	2.21 (56)
J	0.38 (10)	0.50 (13)	–
K	1.13 (29)	1.50 (38)	–
L	0.63 (16)	0.81 (21)	–
M	1.88 (48)	2.31 (59)	–
P	2.43 (62)	2.97 (75)	2.86 (73)
S	–	–	2.36 (60)
T	1.35 (34)	1.78 (45)	–
U	–	–	0.83 (21)
V	2.75 (70)	3.29 (83)	–
Z	0.27 (7)	–	0.30 (7)
Z1	–	0.28 (7)	–

For additional information, and to assist you with piping and connectivity designs, our products are available in downloadable 2D drawings and 3D CAD models in a wide range of options including native formats. Please visit www.rosscontrols.com.

Sub-Bases – Bottom Ported Ordering Information

For Solenoid Pilot or Pressure Controlled Valves

BOTTOM PORTED SUB-BASE

ANSI Size	Outlet Port	Model Number		Avg. C _v
		G Thread	NPT Thread	
10	3/4	D372B91	372B91	10 to 11
	1	D373B91	373B91	10 to 11
	1-1/4	D374B91	374B91	10 to 11
20	1-1/4	D375B91	375B91	22
	1-1/2	D376B91	376B91	22

For Solenoid Pilot or Pressure Controlled Valves

DIMENSIONS

Inches (mm)

for Solenoid Pilot Controlled Valves

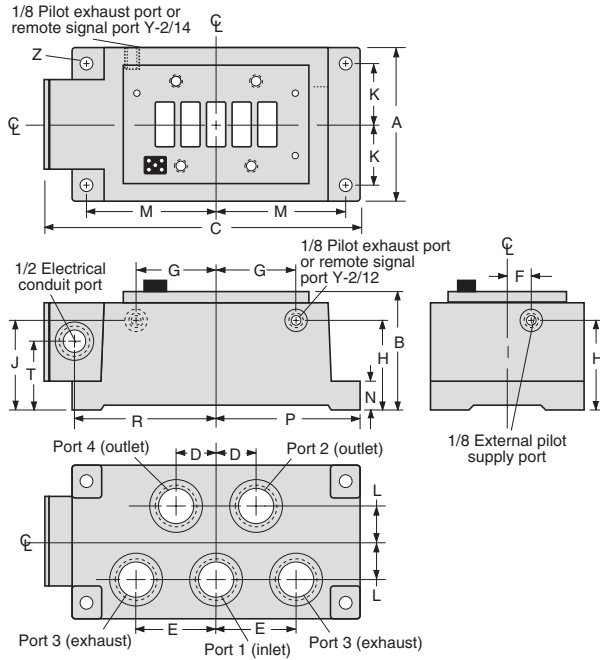

Dimensions inches (mm)		
	ANSI 10	ANSI 20
A	5.8 (129)	6.64 (169)
B	3.78 (96)	3.70 (94)
C	10.45 (266)	12.34 (313)
D	1.38 (35)	1.38 (35)
E	2.76 (70)	2.76 (76)
F	1.03 (26)	1.54 (39)
G	2.60 (66)	3.90 (99)
H	3.01 (76)	2.85 (72)
J	3.25 (83)	2.85 (72)
K	2.05 (52)	2.38 (60)
L	1.22 (31)	1.22 (31)
M	4.33 (110)	5.36 (136)
N	0.88 (22)	1.00 (25)
P	4.76 (121)	5.82 (148)
R	4.65 (118)	5.60 (142)
T	2.50 (64)	2.15 (55)
Z	0.34 (8)	0.37 (9)

for Pressure Controlled Valves

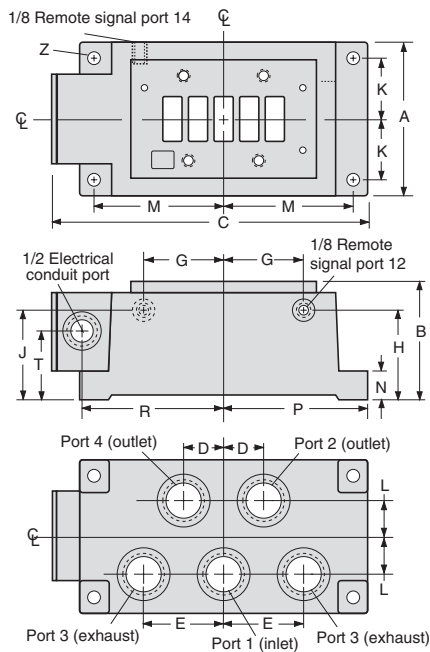

For additional information, and to assist you with piping and connectivity designs, our products are available in downloadable 2D drawings and 3D CAD models in a wide range of options including native formats. Please visit www.rosscontrols.com.

Manifold Bases Ordering Information

For Solenoid Pilot Controlled Valves

MANIFOLD BASES

Indicator Lights in Base	ANSI Size	Outlet Port	Model Number		Avg. C _v
			G Thread	NPT Thread	
None	1	1/4	D502B91	502B91	0.9 to 1.0
		3/8	D503B91	503B91	0.9 to 1.0
	2.5	3/8	D472K91	472K91	2.0 to 2.5
		1/2	D473K91	473K91	2.0 to 2.5
	4	3/8	D377B91	377B91	4.2
		1/2	D378B91	378B91	4.2
		3/4	D379B91	379B91	4.2
	10	3/4	D380B91	380B91	10 to 11
		1	D381B91	381B91	10 to 11
		1-1/4	D382B91	382B91	10 to 11

Indicator Lights in Base	ANSI Size	Outlet Port	Model Number						Avg. C _v
			G Thread			NPT Thread			
			24 V DC	110-120 V AC	230 V AC	24 V DC	110-120 V AC	230 V AC	
One	1	1/4	D531K91-W	D531K91-Z	D531K91-Y	531K91-W	531K91-Z	531K91-Y	0.9 to 1.0
		3/8	D533K91-W	D533K91-Z	D533K91-Y	533K91-W	533K91-Z	533K91-Y	0.9 to 1.0
	2.5	3/8	D478K91-W	D478K91-Z	D478K91-Y	478K91-W	478K91-Z	478K91-Y	2.0 to 2.5
		1/2	D479K91-W	D479K91-Z	D479K91-Y	479K91-W	479K91-Z	479K91-Y	2.0 to 2.5
Two	1	1/4	D532K91-W	D532K91-Z	D532K91-Y	532K91-W	532K91-Z	532K91-Y	0.9 to 1.0
		3/8	D534K91-W	D534K91-Z	D534K91-Y	534K91-W	534K91-Z	534K91-Y	0.9 to 1.0
	2.5	3/8	D480K91-W	D480K91-Z	D480K91-Y	480K91-W	480K91-Z	480K91-Y	2.0 to 2.5
		1/2	D481K91-W	D481K91-Z	D481K91-Y	481K91-W	481K91-Z	481K91-Y	2.0 to 2.5

For other voltages, consult ROSS.

The model numbers of the manifold stations shown on this page specify pressure ports with NPT threads and electrical openings with 1-1/4 NPT threads. All necessary hardware and seals for manifold assembly are included with each manifold station.

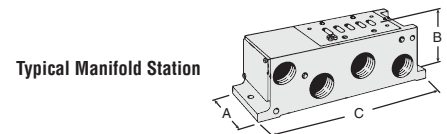

Indicator Lights

As shown in the chart the smaller sizes of manifolds are available with indicator lights. These lights are located in the end plate covering the electrical cavity.

Lights are mounted in bases, on the valves, or on solenoids, depending on the particular type of valve.

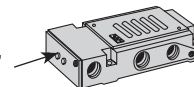

Manifold Note

The port positions of the solenoid controlled and the pressure controlled manifolds are not the same. For this reason these stations cannot be mixed in the same installation. If both types of valves must be used in the same installation, use only manifold stations for solenoid controlled valves.

ASSEMBLED MANIFOLDS

Valves and manifold stations can be assembled by ROSS to precise specifications. The assembly is then ready for integration into your system. For detailed information about such assemblies, consult your ROSS Distributor or call ROSS in the U.S.A. at 1-888-TEK-ROSS (835-7677) or 1-248-764-1800.

For Solenoid Pilot Controlled Valves

DIMENSIONS

Inches (mm)

ANSI Size 1 & 2.5

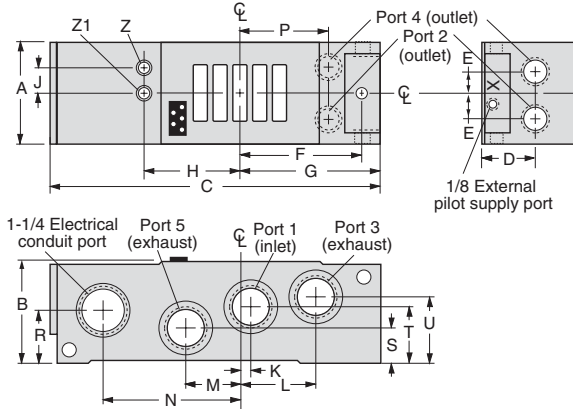

ANSI Size 4

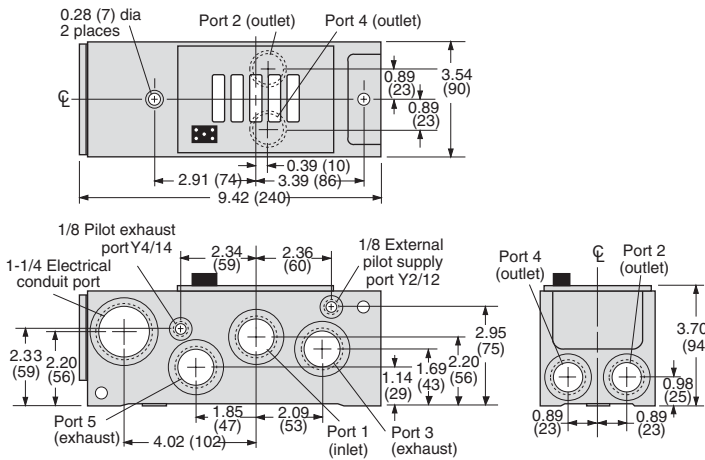

ANSI Size 10

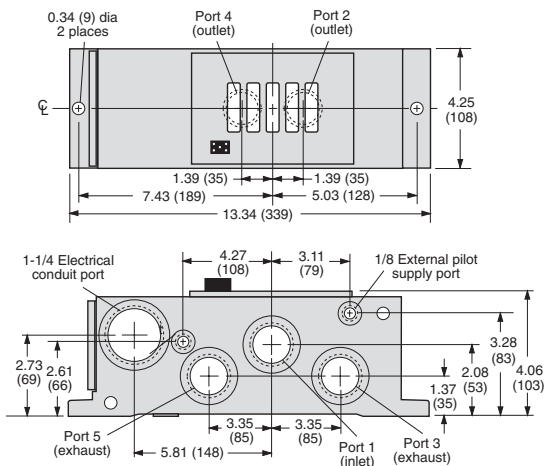

Sub-Base Dimensions inches (mm)

	ANSI SIZE				
	1	2.5	4	10	20
A	2.80 (71)	3.56 (90)	3.36 (85)	5.08 (129)	6.64 (169)
B	1.44 (37)	1.61 (41)	2.64 (67)	3.78 (96)	3.70 (94)
C	6.15 (156)	7.09 (180)	7.21 (183)	10.45 (266)	12.34 (313)
D	0.51 (13)	0.63 (16)	0.75 (19)	1.38 (35)	1.38 (35)
E	0.88 (22)	1.25 (32)	1.50 (38)	2.76 (70)	2.76 (70)
F	0.78 (20)	0.93 (23)	1.23 (31)	1.75 (44)	1.59 (40)
H	0.58 (15)	0.63 (16)	2.21 (56)	3.01 (76)	2.85 (72)
J	0.38 (10)	0.50 (13)	-	-	-
K	1.13 (29)	1.50 (38)	-	2.05 (52)	2.38 (60)
M	1.88 (48)	2.31 (59)	-	4.33 (110)	5.35 (136)
P	2.43 (62)	2.97 (75)	2.86 (73)	4.76 (121)	5.86 (149)
S	-	-	2.36 (60)	-	-
T	1.35 (34)	1.78 (45)	-	-	-
U	-	-	0.83 (21)	1.97 (50)	1.54 (39)
V	2.75 (70)	3.29 (83)	3.07 (78)	4.65 (118)	5.60 (142)
W	-	-	1.23 (31)	2.50 (64)	2.15 (55)
Z	0.27 (7)	-	0.30 (7)	-	-
Z1	-	0.28 (7)	-	0.34 (9)	0.37 (9)

For additional information, and to assist you with piping and connectivity designs, our products are available in downloadable 2D drawings and 3D CAD models in a wide range of options including native formats. Please visit www.rosscontrols.com.

Manifold Bases Ordering Information

For Pressure Controlled Valves

MANIFOLD BASES

Indicator Lights in Base	ANSI Size	Outlet Port	Model Number		Avg. C _v
			G Thread	NPT Thread	
None	1	1/4	D359B91	359B91	0.9 to 1.0
		3/8	D360B91	360B91	0.9 to 1.0
	2.5	3/8	D468B91	468B91	2.0 to 2.5
		1/2	D469B91	469B91	2.0 to 2.5
	4	3/8	D383B91	383B91	4.2
		1/2	D384B91	384B91	4.2
		3/4	D385B91	385B91	4.2
	10	3/4	D386B91	386B91	10 to 11
		1	D387B91	387B91	10 to 11
		1-1/4	D388B91	388B91	10 to 11

The numbers of the manifold stations shown in the chart on the right specify pressure ports with NPT threads. All necessary hardware and seals for manifold assembly are included with each manifold station.

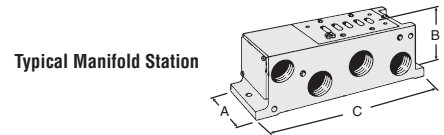

Manifold Note

The port positions of the solenoid controlled and the pressure controlled manifolds are not the same. For this reason these stations cannot be mixed in the same installation. If both types of valves must be used in the same installation, use only manifold stations for solenoid controlled valves.

ASSEMBLED MANIFOLDS

Valves and manifold stations can be assembled by ROSS to precise specifications. The assembly is then ready for integration into your system. For detailed information about such assemblies, consult your ROSS Distributor or call ROSS in the U.S.A. at 1-888-TEK-ROSS (835-7677) or 1-248-764-1800.

For Pressure Controlled Valves

DIMENSIONS

Inches (mm)

ANSI Size 1 & 2.5

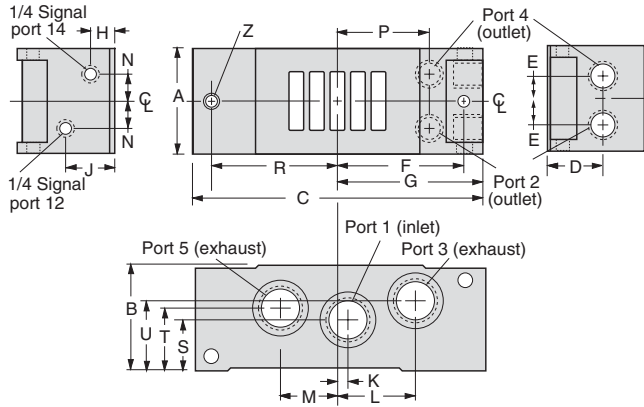

ANSI Size 4

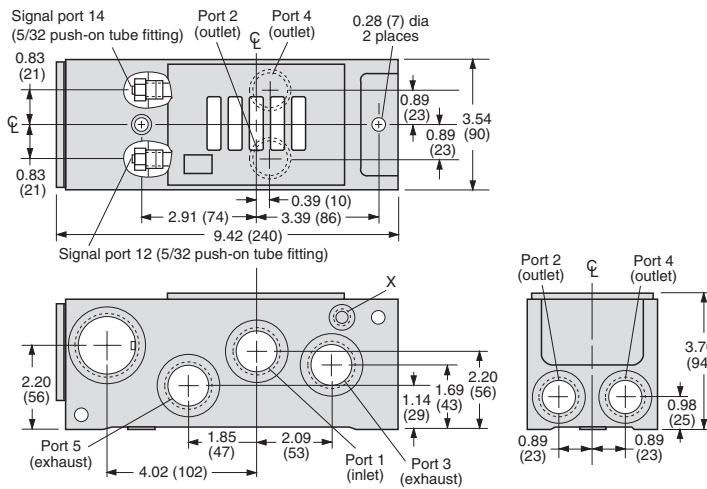

ANSI Size 10

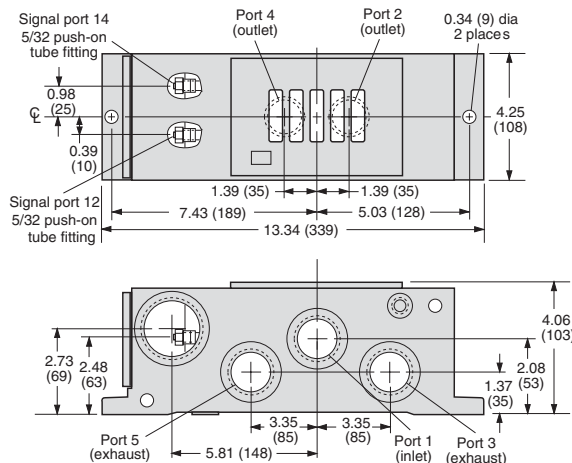

Dimensions inches (mm)		
	ANSI 1	ANSI 2.5
A	2.26 (57)	2.80 (71)
B	2.26 (57)	2.66 (68)
C	6.25 (159)	6.86 (174)
D	1.32 (34)	1.48 (38)
E	0.56 (14)	0.70 (18)
F	2.88 (73)	2.99 (76)
G	3.31 (84)	3.40 (86)
H	0.56 (14)	0.74 (19)
J	0.88 (22)	1.26 (32)
K	0.00 (00)	0.18 (6)
L	1.47 (37)	1.80 (46)
M	1.36 (35)	1.46 (37)
N	0.56 (14)	0.70 (18)
P	2.37 (60)	2.21 (56)
R	2.50 (64)	2.99 (76)
S	1.14 (29)	1.40 (36)
T	1.14 (29)	1.76 (45)
U	1.26 (32)	1.76 (45)
Z	0.28 (7)	0.28 (7)

For additional information, and to assist you with piping and connectivity designs, our products are available in downloadable 2D drawings and 3D CAD models in a wide range of options including native formats. Please visit www.rosscontrols.com.

Accessories

SOLENOID PILOT OPTIONS

Manual Override Kits	Flush Button		Extended Button		Extended Button with Palm	
	Locking Type	Kit Number	Locking Type	Kit Number	Locking Type	Kit Number
	Non-Locking	790K87	Non-Locking	791K87	Non-Locking	984H87
Locking	792K87					

Flush flexible manual overrides are standard on solenoid pilot controlled valves with C_v ratings of 2.0 or larger. Both locking and non-locking metal override buttons are also available for these models.

Each of the override buttons in the kits at the right is made of metal and is spring-returned. The locking type button, however, can be kept in the actuated position by turning the slot in the top of the button with a screwdriver.

INTERPOSED PRESSURE REGULATORS

ANSI Size	Model Number		
	Single	Double	
		Solenoid	Remote Air
1	840C91	841C91	713C91
2.5	626C91	627C91	714C91
4	632C91	633C91	715C91

Both single and double interposed regulators are available for valves with C_v ratings up to 4.2. A regulator is bolted to the valve's sub-base or manifold station, and the valve is then bolted to the regulator. This mounting method allows the valve to be removed and replaced without disturbing the regulator.

Single pressure regulators provide the same regulated pressure at both outlet ports. Double pressure regulators allow the pressure at each outlet port to be set independently.

A locking type knob is used to set the regulated pressure at any point in the range of:

- 5 to 100 psig (0.3 to 7 bar) for ANSI Size 1 and 2 models;
- 5 to 125 psig (0.3 to 8.5 bar) for ANSI Size = 4.2 models.

Maximum inlet pressure is 150 psig (10 bar).
Pressure gauge(s) included.

Warning Double interposed regulators will reverse output ports - the 12 solenoid will pressurize the 4 port, the 14 solenoid will pressurize the 2 port - which may cause unexpected, potentially dangerous cylinder movement at valve pressurization.

EXHAUST SILENCERS

Port Size	Thread Type	Model Number		Flow Avg. C _v	Pressure Range psig (bar)
		R/Rp Thread	NPT Thread		
1/4	Male	D5500A2003	5500A2003	2.1	0-290 (0-20) maximum
3/8	Male	D5500A3013	5500A3013	2.7	
		D5500A3003	5500A3003	4.3	
1/2	Male	D5500A4003	5500A4003	4.7	
3/4	Male	D5500A5013	5500A5013	5.1	
		D5500A5003	5500A5003	11.5	
1	Male	D5500A6003	5500A6003	14.6	
1-1/4	Male	D5500A7013	5500A7013	16.4	

CAUTIONS, WARNINGS And STANDARD WARRANTY



ROSS OPERATING VALVE, ROSS CONTROLS®, ROSS DECCO®, and AUTOMATIC VALVE INDUSTRIAL, collectively the “ROSS Group”.

PRE-INSTALLATION or SERVICE

1. Before servicing a valve or other pneumatic component, be sure all sources of energy are turned off, the entire pneumatic system is shut down and exhausted, and all power sources are locked out (ref: OSHA 1910.147, EN 1037).
2. All ROSS Group Products, including service kits and parts, should be installed and/or serviced only by persons having training and experience with pneumatic equipment. Because any product can be tampered with and/or need servicing after installation, persons responsible for the safety of others or the care of equipment must check ROSS Group Products on a regular basis and perform all necessary maintenance to ensure safe operating conditions.
3. All applicable instructions should be read and complied with before using any fluid power system to prevent harm to persons or equipment. In addition, overhauled or serviced valves must be functionally tested prior to installation and use. If you have any questions, call your nearest ROSS Group location.
4. Each ROSS Group Product should be used within its specification limits. In addition, use only ROSS Group components to repair ROSS Group Products.

WARNINGS:

Failure to follow these instructions can result in personal injury and/or property damage.

FILTRATION and LUBRICATION

1. Dirt, scale, moisture, etc., are present in virtually every air system. Although some valves are more tolerant of these contaminants than others, best performance will be realized if a filter is installed to clean the air supply, thus preventing contaminants from interfering with the proper performance of the equipment. The ROSS Group recommends a filter with a 5-micron rating for normal applications.
2. All standard ROSS Group filters and lubricators with polycarbonate plastic bowls are designed for compressed air applications only. Use the metal bowl guard, where provided, to minimize danger from high pressure fragmentation in the event of bowl failure. Do not expose these products to certain fluids, such as alcohol or liquefied petroleum gas, as they can cause bowls to rupture, creating a combustible condition and hazardous leakage. Immediately replace crazed, cracked, or deteriorated bowls.
3. Only use lubricants which are compatible with materials used in the valves and other components in the system. Normally, compatible lubricants are petroleum base oils with oxidation inhibitors, an aniline point between 180°F (82°C) and 220°F (104°C), and an ISO 32, or lighter, viscosity. Avoid oils with

phosphate type additives which can harm polyurethane components, potentially leading to valve failure which risks personal injury, and/or damage to property.

WARNINGS:

Failure to follow these instructions can result in personal injury and/or property damage.

AVOID INTAKE/EXHAUST RESTRICTION

1. Do not restrict air flow in the supply line. To do so could reduce the pressure of the supply air below minimum requirements for the valve and thereby causing erratic action.
2. Do not restrict a valve's exhaust port as this can adversely affect its operation. Exhaust silencers must be resistant to clogging and must have flow capacities at least as great as the exhaust capacities of the valves. Contamination of the silencer can result in reduced flow and increased back pressure.

WARNINGS: Failure to follow these instructions can result in personal injury and/or property damage.

SAFETY APPLICATIONS

1. Mechanical Power Presses and other potentially hazardous machinery using a pneumatically controlled clutch and brake mechanism must use a press control double valve with a monitoring device. A double valve without a self-contained monitoring device should be used only in conjunction with a control system which assures monitoring of the valve. All double valve installations involving hazardous applications should incorporate a monitoring system which inhibits further operation of the valve and machine in the event of a failure within the valve mechanism.
2. Safe Exhaust (dump) valves without a self-contained monitoring device should be used only in conjunction with a control system which assures monitoring of the valve. All Safe Exhaust valve installations should incorporate a monitoring system which inhibits further operation of the valve and machine in the event of a failure within the valve mechanism.
3. Per specifications and regulations, the ROSS L-O-X® and L-O-X® with EEZ-ON®, N06 and N16 Series operation products are defined as energy isolation devices, NOT AS EMERGENCY STOP DEVICES.

WARNINGS:

Failure to follow these instructions can result in personal injury and/or property damage.

STANDARD WARRANTY

All products sold by the ROSS Group are warranted for a one-year period [with the exception of Filters, Regulators and Lubricators (“FRLs”) which are warranted for a period of seven (7) years] from the date of purchase. All products are, during their respective warranty periods, warranted to be free of defects in material and workmanship. The ROSS Group's obligation under this warranty is limited to repair, replacement or refund of the purchase price paid for products which the ROSS Group has determined, in its sole discretion, are defective. All warranties become void if a product has been subject to misuse, misapplication, improper maintenance, modification or tampering. Products for which warranty protection is sought must be returned to the ROSS Group freight prepaid.

THE WARRANTY EXPRESSED ABOVE IS IN LIEU OF AND EXCLUSIVE OF ALL OTHER WARRANTIES AND THE ROSS GROUP EXPRESSLY DISCLAIMS ALL OTHER WARRANTIES EITHER EXPRESSED OR IMPLIED WITH RESPECT TO MERCHANTABILITY OR FITNESS FOR A PARTICULAR PURPOSE. THE ROSS GROUP MAKES NO WARRANTY WITH RESPECT TO ITS PRODUCTS MEETING THE PROVISIONS OF ANY GOVERNMENTAL OCCUPATIONAL SAFETY AND/OR HEALTH LAWS OR REGULATIONS. IN NO EVENT IS THE ROSS GROUP LIABLE TO PURCHASER, USER, THEIR EMPLOYEES OR OTHERS FOR INCIDENTAL OR CONSEQUENTIAL DAMAGES WHICH MAY RESULT FROM A BREACH OF THE WARRANTY DESCRIBED ABOVE OR THE USE OR MISUSE OF THE PRODUCTS. NO STATEMENT OF ANY REPRESENTATIVE OR EMPLOYEE OF THE ROSS GROUP MAY EXTEND THE LIABILITY OF THE ROSS GROUP AS SET FORTH HEREIN.



AMERICAS	ROSS CONTROLS	USA	Tel: +1-248-764-1800	www.rosscontrols.com
	ROSS CONTROLS CANADA Ltd.	Canada	Tel: +1-416-251-7677	www.rosscanada.com
	ROSS DO BRASIL EIRELI	Brazil	Tel: +55-11-4335-2200	www.rosscontrols.com.br
EUROPE	ROSS EUROPA GmbH	Germany	Tel: +49 (0)6103-7597-100	www.rosseuropa.com
	ROSS FRANCE SAS	France	Tel: +33-(0)1-49-45-65-65	www.rossfrance.com
	ROSS PNEUMATROL Ltd.	United Kingdom	Tel: +44 (0)1254 872277	www.rossuk.co.uk
ASIA & PACIFIC	ROSS CONTROLS INDIA Pvt. Ltd.	India	Tel: +91-44-2624-9040	www.rosscontrolsindia.com
	ROSS CONTROLS (CHINA) Ltd.	China	Tel: +86-21-6915-7961	www.rosscontrolschina.com
	ROSS ASIA K.K.	Japan	Tel: +81-42-778-7251	www.rossasia.co.jp
	AUTOMATIC VALVE INDUSTRIAL LLC	USA	Tel: +1-248-474-6700	www.automaticvalve.com
	ROSS DECCO COMPANY	USA	Tel: +1-248-764-1800	www.rossdecco.com
	ROSS PNEUMATROL Ltd.	United Kingdom	Tel: +44 (0)1254 872277	www.pneumatrol.com
	manufactIS GmbH	Germany	Tel: +49 (0)2013-16843-0	www.manufactis.net

Full-Service Global Locations

There are ROSS Distributors Throughout the World

To meet your requirements across the globe, ROSS distributors are located throughout the world. Through ROSS or its distributors, guidance is available for the selection of ROSS products, both for those using fluid power components for the first time and those designing complex systems.

Other literature is available for engineering, maintenance, and service requirements.

If you need products or specifications not shown in this catalog, please visit ROSS' website, contact ROSS or your ROSS distributor. The ROSS Support Team will be happy to assist you in selecting the best product for your application.

For a current list of countries and local distributors, visit ROSS' at www.rosscontrols.com.