



AIR PREPARATION PRESSURE REGULATORS



ROSS CONTROLS

PRESSURE REGULATORS – KEY FEATURES

- Two design options available:
Piston design for highest air flow
Diaphragm design for high sensitivity and quick response
- Modular or In-line Mounting options
- Pressure Gauge included
- Removable Adjusting Knob for tamper resistance
- Self-relieving or non-relieving options
- Reverse Flow option available on some regulator models
- T-Handle option available on some regulator models

| REGULATOR TYPE/SERIES | AVAILABLE PORT SIZES | | | | | | | | | | MOUNTING | | FLOW | CONSTRUCTION | | OPTIONS | | | | | Page | |
|---------------------------------|----------------------|-----|-----|-----|-----|---|----|----|---|---|----------|---------|-----------------|--------------|-----------|----------------|---------------|--------------|----------|--------------|------|---------------|
| | 1/8 | 1/4 | 3/8 | 1/2 | 3/4 | 1 | 1¼ | 1½ | 2 | 3 | IN-LINE | MODULAR | MAX FLOW (scfm) | PISTON | DIAPHRAGM | SELF RELIEVING | NON RELIEVING | REVERSE FLOW | T-HANDLE | LOCKING KNOB | | |
| STANDARD REGULATORS | | | | | | | | | | | | | | | | | | | | | | |
| RIGHT-ANGLE | | | | | | | | | | | | | 55 | | | | | | | | | G2.3 |
| BANTAM | | | | | | | | | | | | | 23 | | | | | | | | | G2.4 |
| MINIATURE | | | | | | | | | | | | | 40 | | | | | | | | | G2.5 |
| MID-SIZE | | | | | | | | | | | | | 100 | | | | | | | | | G2.6 |
| MD3™ | | | | | | | | | | | | | 120 | | | | | | | | | G2.7 |
| FULL-SIZE | | | | | | | | | | | | | 155 | | | | | | | | | G2.8 |
| MD4™ | | | | | | | | | | | | | 220 | | | | | | | | | G2.9 |
| HIGH-CAPACITY | | | | | | | | | | | | | 800 | | | | | | | | | G2.10 |
| HIGH-PRESSURE REGULATORS | | | | | | | | | | | | | | | | | | | | | | |
| HIGH-PRESSURE | | | | | | | | | | | | | 70 | | | | | | | | | G2.11 |
| PRECISION REGULATORS | | | | | | | | | | | | | | | | | | | | | | |
| MINIATURE | | | | | | | | | | | | | 4 | | | | | | | | | G2.12 |
| FULL-SIZE | | | | | | | | | | | | | 155 | | | | | | | | | G2.13 |
| MD4™ | | | | | | | | | | | | | 170 | | | | | | | | | G2.14 |
| HIGH-CAPACITY | | | | | | | | | | | | | 800 | | | | | | | | | G2.15 |
| REMOTE PILOT REGULATORS | | | | | | | | | | | | | | | | | | | | | | |
| FULL-SIZE | | | | | | | | | | | | | 155 | | | | | | | | | G2.16 - G2.18 |
| MD4™ | | | | | | | | | | | | | 190 | | | | | | | | | G2.19 |
| HIGH-CAPACITY | | | | | | | | | | | | | 4000 | | | | | | | | | G2.20 - G2.23 |
| RELIEF VALVES | | | | | | | | | | | | | | | | | | | | | | |
| MINIATURE | | | | | | | | | | | | | 40 | | | | | | | | | G2.24 |
| HIGH-FLOW | | | | | | | | | | | | | 450 | | | | | | | | | G2.25 |
| PROPORTIONAL VALVES | | | | | | | | | | | | | | | | | | | | | | |
| RER Series | | | | | | | | | | | | | 1000 | | | | | | | | | G2.26 |
| RB-RER Series | | | | | | | | | | | | | 4000 | | | | | | | | | G2.27 |

In-line Pressure Regulators

RIGHT-ANGLE Series

Port Sizes: 1/8, 1/4, 3/8 & 1/2 – Flow to 55 scfm

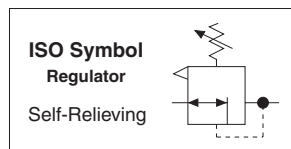
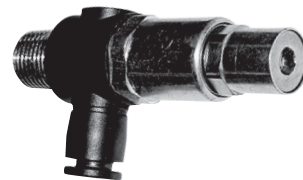

| Models with Threaded Banjo | | | | | | |
|----------------------------|-----------------------|--------------|--------------|------------------------|----------|-----------------------------------|
| Port Size | | Port Threads | Model Number | Dimensions inches (mm) | | Tightening Torque Max. Ft-lb (Nm) |
| Port 1 (female threads) | Port 2 (male threads) | | | A | B | |
| 1/8 | 1/8 | NPT | 5214A1010 | 0.7 (17) | 2.9 (74) | 7.38 (10) |
| 1/4 | 1/4 | NPT | 5214A2010 | 0.7 (17) | 3.2 (81) | 8.85 (12) |
| 3/8 | 3/8 | NPT | 5214A3010 | 0.9 (22) | 3.5 (88) | 14.75 (20) |
| 1/2 | 1/2 | NPT | 5214A4010 | 1.1 (27) | 3.5 (89) | 22.13 (30) |
| 1/8 | 1/8 | G | D5214A1010 | 0.7 (17) | 2.9 (74) | 11.06 (15) |
| 1/4 | 1/4 | G | D5214A2010 | 0.7 (17) | 3.2 (81) | 14.75 (20) |
| 3/8 | 3/8 | G | D5214A3010 | 0.9 (22) | 3.5 (88) | 22.13 (20) |
| 1/2 | 1/2 | G | D5214A4010 | 1.1 (27) | 3.5 (89) | 22.50 (30) |

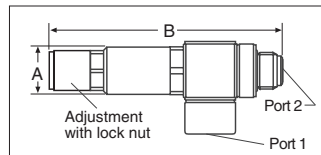

| Models with Push-to-Connect Fitting | | | | | |
|-------------------------------------|------------------------|--------------------|------------------------|----------|-----------------------------------|
| Port Size | | Valve Model Number | Dimensions inches (mm) | | Tightening Torque Max. Ft-lb (Nm) |
| Port 1# (tube size) | Port 2** (thread size) | | A | B | |
| 1/4" | 1/8 NPT | 5214A1120 | 0.7 (17) | 2.9 (73) | 11.06 (15) |
| 1/4" | 1/4 NPT | 5214A2120 | 0.7 (17) | 3.2 (81) | 14.75 (20) |
| 3/8" | 1/4 NPT | 5214A2130 | 0.7 (17) | 3.2 (81) | 14.75 (20) |
| 3/8" | 3/8 NPT | 5214A3130 | 0.9 (22) | 3.5 (88) | 22.13 (30) |
| 4 mm | 1/8 G | D5214A1140 | 0.5 (13) | 2.9 (73) | 7.38 (10) |
| 6 mm | 1/8 G | D5214A1160 | 0.5 (13) | 2.9 (73) | 7.38 (10) |
| 8 mm | 1/8 G | D5214A1180 | 0.5 (13) | 2.9 (73) | 7.38 (10) |
| 6 mm | 1/4 G | D5214A2160 | 0.7 (17) | 3.2 (81) | 8.85 (12) |
| 8 mm | 1/4 G | D5214A2180 | 0.7 (17) | 3.2 (81) | 8.85 (12) |
| 10 mm | 1/4 G | D5214A2110 | 0.7 (17) | 3.2 (81) | 8.85 (12) |
| 8 mm | 3/8 G | D5214A3180 | 0.9 (22) | 3.5 (88) | 14.75 (20) |
| 10 mm | 3/8 G | D5214A3110 | 0.9 (22) | 3.5 (88) | 14.75 (20) |

Port 1 tubing size in inches (") or millimeters (mm). ** Port 2 threads are male.

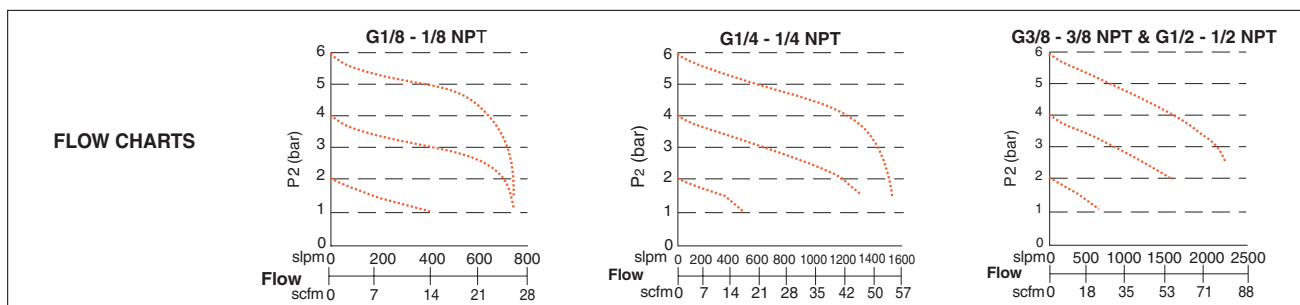
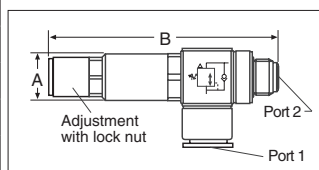

STANDARD SPECIFICATIONS (for regulators on this page):

| | | | |
|---------------------|--|---------------------------|------------------------------|
| Construction Design | Self-relieving | Operating Pressure | 15 to 240 psig (1 to 17 bar) |
| Temperature | Ambient/Media: 15° to 160°F (-10° to 70°C) | Regulated Pressure Range: | 15 to 120 psig (1 to 8 bar). |
| Fluid Media | Filtered air | Construction Material | Bowl: Metal |

IMPORTANT NOTE: Please read carefully and thoroughly all of the **CAUTIONS, WARNINGS** on the inside back cover.



Online Version
02/01/21



www.rosscontrols.com

Modular Regulators

BANTAM Series

Port Sizes: 1/8, 1/4 & 3/8 – Flow to 23 scfm

| Port Size | Piston | | | Diaphragm | | |
|---|-------------------------------|---------------|---------------|-------------------------------|---------------|---------------|
| | Model Number | | | Model Number | | |
| | Regulated Pressure psig (bar) | | | Regulated Pressure psig (bar) | | |
| | 0-50 (0-3.4) | 0-100 (0-6.9) | 0-125 (0-8.6) | 0-50 (0-3.4) | 0-100 (0-6.9) | 0-125 (0-8.6) |
| With THREADED PORTS | | | | | | |
| 1/8 NPTF | 5B01C0030 | 5B01C0010 | 5B01C0050 | 5B01C0040 | 5B01C0020 | 5B01C0060 |
| 1/8 G | C5B01C0030 | C5B01C0010 | C5B01C0050 | C5B01C0040 | C5B01C0020 | C5B01C0060 |
| 1/4 NPTF | 5B02C0030 | 5B02C0010 | 5B02C0050 | 5B02C0040 | 5B02C0020 | 5B02C0060 |
| 1/4 G | C5B02C0030 | C5B02C0010 | C5B02C0050 | C5B02C0040 | C5B02C0020 | C5B02C0060 |
| With Quick Connect TUBE FITTINGS | | | | | | |
| 1/4 | 5B03C0030 | 5B03C0010 | 5B03C0050 | 5B03C0040 | 5B03C0020 | 5B03C0060 |
| 3/8 | 5B04C0030 | 5B04C0010 | 5B04C0050 | 5B04C0040 | 5B04C0020 | 5B04C0060 |
| 4mm | 5B05C0030 | 5B05C0010 | 5B05C0050 | 5B05C0040 | 5B05C0020 | 5B05C0060 |
| 6mm | 5B06C0030 | 5B06C0010 | 5B06C0050 | 5B06C0040 | 5B06C0020 | 5B06C0060 |
| 8mm | 5B07C0030 | 5B07C0010 | 5B07C0050 | 5B07C0040 | 5B07C0020 | 5B07C0060 |
| 10mm | 5B08C0030 | 5B08C0010 | 5B08C0050 | 5B08C0040 | 5B08C0020 | 5B08C0060 |

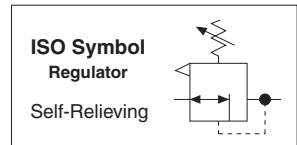

| Port Size | Dimensions inches (mm) | | | | Weight lb (kg) |
|---------------------|------------------------|----------|----------|----------|----------------|
| | A | B | C | Depth* | |
| No Port | 1.7 (43) | 2.6 (67) | 0.5 (13) | 1.8 (45) | 0.21 (0.09) |
| 1/8, 1/4 (NPT or G) | 3.0 (76) | 2.6 (67) | 0.5 (13) | 1.8 (45) | 0.43 (0.19) |

Models below have quick-connect tube fittings.

| | | | | | |
|-------|----------|----------|----------|----------|-------------|
| 1/4 | 3.4 (86) | 2.6 (67) | 0.5 (13) | 1.8 (45) | 0.21 (0.09) |
| 3/8 | 3.9 (99) | 2.6 (67) | 0.5 (13) | 1.8 (45) | 0.21 (0.09) |
| 4 mm | 3.4 (86) | 2.6 (67) | 0.5 (13) | 1.8 (45) | 0.41 (0.18) |
| 6 mm | 3.4 (86) | 2.6 (67) | 0.5 (13) | 1.8 (45) | 0.41 (0.18) |
| 8 mm | 3.1 (79) | 2.6 (67) | 0.5 (13) | 1.8 (45) | 0.41 (0.18) |
| 10 mm | 3.9 (99) | 2.6 (67) | 0.5 (13) | 1.8 (45) | 0.41 (0.18) |

* Less gauge.

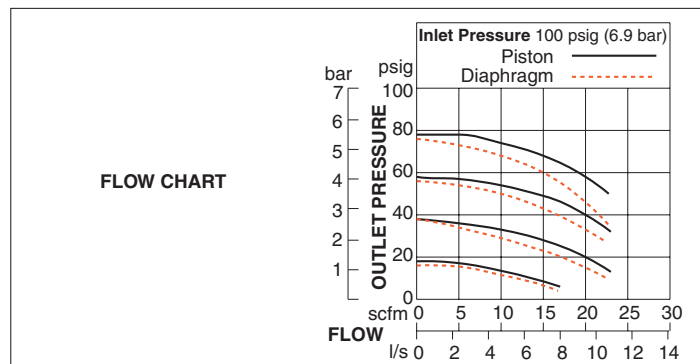
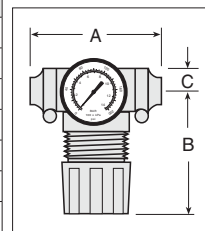

Pressure Gauge included.
Accessories ordered separately, refer to page G6.3-4.

STANDARD SPECIFICATIONS (for regulators on this page):

| | | | |
|---------------------|---|-----------------------|---|
| Construction Design | Piston or Diaphragm Self-relieving; For non-relieving option consult ROSS. | Pressure Gauge | 0 to 160 psig (0 to 11 bar); 1/8 gauge ports front and rear |
| Temperature | Ambient/Media: 40° to 125°F (4° to 52°C) | Panel Mounting | 1-3/16 inch (30 mm) hole required |
| Fluid Media | Compressed air | Construction Material | Body: Acetal |
| Operating Pressure | Inlet: Maximum 150 psig (10 bar) Outlet: Adjustable up to 100 psig (7 bar) | | Dome and Knob: Acetal |
| | | | Seals: Nitrile |

IMPORTANT NOTE: Please read carefully and thoroughly all of the **CAUTIONS, WARNINGS** on the inside back cover.

Port Sizes: 1/8 & 1/4 – Flow to 40 scfm



| Port Size | Port Threads | Piston | | | Diaphragm | | |
|-----------|--------------|-------------------------------|---------------|---------------|-------------------------------|---------------|---------------|
| | | Model Number | | | Model Number | | |
| | | Regulated Pressure psig (bar) | | | Regulated Pressure psig (bar) | | |
| | | 0-50 (0-3.4) | 0-100 (0-6.9) | 0-125 (0-8.6) | 0-50 (0-3.4) | 0-100 (0-6.9) | 0-125 (0-8.6) |
| 1/8 | NPTF | 5212C1004 | 5211C1004 | 5213C1004 | 5212C1005 | 5211C1005 | 5213C1005 |
| | G | C5212C1004 | C5211C1004 | C5213C1004 | C5212C1005 | C5211C1005 | C5213C1005 |
| 1/4 | NPTF | 5212C2004 | 5211C2004 | 5213C2004 | 5212C2005 | 5211C2005 | 5213C2005 |
| | G | C5212C2004 | C5211C2004 | C5213C2004 | C5212C2005 | C5211C2005 | C5213C2005 |

| Port Size | Dimensions inches (mm) | | | | Weight* lb (kg) |
|-----------|------------------------|----------|----------|----------|--------------------|
| | A | B | C | Depth* | |
| 1/8, 1/4 | 1.6 (41) | 2.7 (68) | 0.4 (10) | 1.6 (41) | 0.24 (0.11) |

* Less gauge.

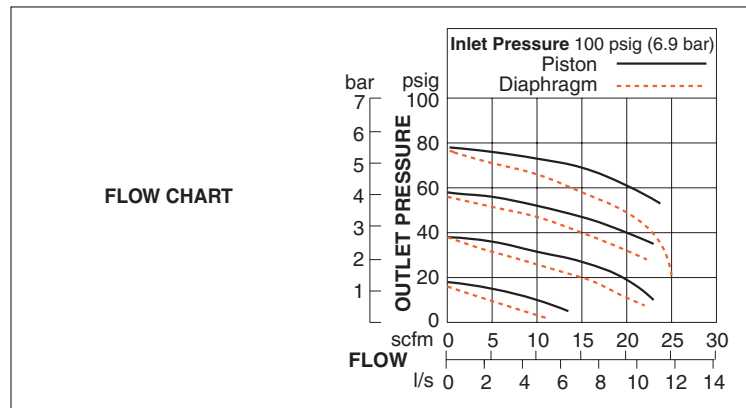
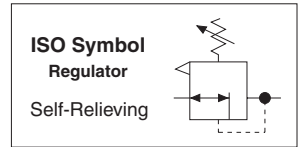
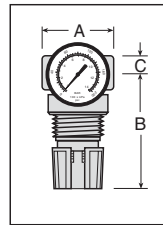

Pressure Gauge included.
Accessories ordered separately, refer to page G6.3-4.

STANDARD SPECIFICATIONS (for regulators on this page):

| | | | |
|---------------------|---|-----------------------|---|
| Construction Design | Piston or Diaphragm Self-relieving; For non-relieving option consult ROSS. | Pressure Gauge | 0 to 160 psig (0 to 11 bar); 1/8 gauge ports front and rear |
| Temperature | Ambient/Media: 40° to 125°F (4° to 52°C) | Panel Mounting | 1-3/16 inch (30 mm) hole required |
| Fluid Media | Compressed air | Construction Material | Body: Aluminum |
| Operating Pressure | Inlet: Maximum 300 psig (21 bar) Outlet: Adjustable up to 100 psig (7 bar) | | Dome and Knob: Acetal |
| | | | Seals: Nitrile |

IMPORTANT NOTE: Please read carefully and thoroughly all of the **CAUTIONS, WARNINGS** on the inside back cover.

Port Sizes: 1/4, 3/8 & 1/2 – Flow to 100 scfm

| Port Size | Pressure Range psig (bar) | | | | | |
|-----------|---------------------------|------------|---------------|------------|----------------|------------|
| | 0-50 (0-3.4) | | 0-100 (0-6.9) | | 0-150 (0-10.3) | |
| | Model Number | | Model Number | | Model Number | |
| | NPTF Threads | G Threads | NPTF Threads | G Threads | NPTF Threads | G Threads |
| 1/4 | 5212B2015 | C5212B2015 | 5211B2015 | C5211B2015 | 5213B2015 | C5213B2015 |
| 3/8 | 5212B3015 | C5212B3015 | 5211B3015 | C5211B3015 | 5213B3015 | C5213B3015 |
| 1/2 | 5212B4015 | C5212B4015 | 5211B4015 | C5211B4015 | 5213B4015 | C5213B4015 |



| REGULATORS with REVERSE FLOW | | | | | |
|------------------------------|-------------------------------------|---------------------|--------------|---------------|--------------|
| Port Size | Regulated Pressure Range psig (bar) | Pressure Adjustment | | | |
| | | Knob | | T-Handle | |
| | | Model Numbers | | Model Numbers | |
| | | NPTF Threads | BSPP Threads | NPTF Threads | BSPP Threads |
| 1/4 | 0-100 (0-6.9) | 5X00B2035 | C5X00B2035 | 5X00B2039 | C5X00B2039 |
| 3/8 | 0-100 (0-6.9) | 5X00B3024 | C5X00B3024 | 5X00B3021 | C5X00B3021 |
| 1/2 | 0-100 (0-6.9) | 5X00B4023 | C5X00B4023 | 5X00B4041 | C5X00B4041 |

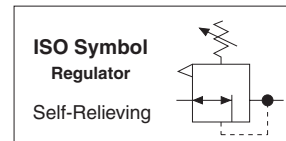

| Port Size | Dimensions inches (mm) | | | | Weight* lb (kg) |
|---------------|------------------------|----------|----------|----------|--------------------|
| | A | B | C | Depth* | |
| 1/4, 3/8, 1/2 | 2.7 (68) | 3.3 (83) | 1.3 (33) | 2.1 (52) | 1.0 (0.46) |

*Less gauge.

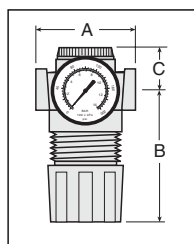

Reverse-Flow Regulators provide regulated in-to-out pressure control, plus quick exhausting from out-to-in. Used for downstream pressure regulation of weld guns and other applications requiring quick exhausting through the regulator.

FLOW CHART

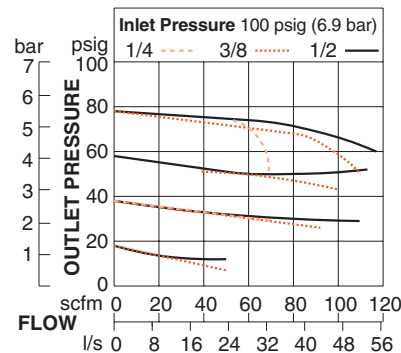

Pressure Gauge included.
Accessories ordered separately, refer to page G6.3-4.

STANDARD SPECIFICATIONS (for regulators on this page):

| | | | |
|---------------------|--|-----------------------|-----------------------------------|
| Construction Design | Piston or Diaphragm Self-relieving; For non-relieving option consult ROSS. | Panel Mounting | 1-9/16 inch (40 mm) hole required |
| Temperature | Ambient/Media: 40° to 125°F (4° to 52°C) | Construction Material | Body: Zinc |
| Fluid Media | Compressed air | | Cap: Nylon |
| Operating Pressure | Inlet: Maximum 250 psig (17 bar) Outlet: Adjustable up to 150 psig (10 bar) | | Dome: Acetal |
| Pressure Gauge | 0 to 200 psig (0 to 14 bar); 1/4 NPT gauge ports front and rear | | Knob: Acetal |
| | | | Seals: Nitrile |

IMPORTANT NOTE: Please read carefully and thoroughly all of the **CAUTIONS, WARNINGS** on the inside back cover.

Port Sizes: 1/4, 3/8 & 1/2 – Flow to 120 scfm

Choose your options (in red) to configure your model number.

MD3 **52K** **A** **R** **C** **2** **2** **A**

| ADJUSTMENT TYPE | |
|-----------------|------------|
| Knob | 52K |
| Tee Handle | 52T |
| Locking Knob | 52L |

| ADJUSTMENT RANGE | |
|-------------------------|----------|
| 0-200 psig (0-13.8 bar) | A |
| 0-150 psig (0-10.3 bar) | B |
| 0-100 psig (0-6.9 bar) | C |
| 0-50 psig (0-3.4 bar) | D |

| PIPE SIZE | |
|-----------|----------|
| 1/4 NPTF | 2 |
| 3/8 NPTF | 3 |
| 1/2 NPTF | 4 |
| 1/4 G | B |
| 3/8 G | C |
| 1/2 G | D |

| FLOW OPTIONS | |
|---------------|----------|
| Reverse Flow | R |
| Standard Flow | S |

| GAUGE | |
|---|----------|
| Without Gauge | A |
| Gauge 0-200 psig (0-13.8 bar) | B |
| Gauge 0-60 psig (0-4.1 bar) | C |
| Without Gauge, with Panel Mount Nut | D |
| Gauge 0-200 psig (0-13.8 bar), with Panel Mount Nut | E |
| Gauge 0-60 psig (0-4.1 bar), with Panel Mount Nut | F |

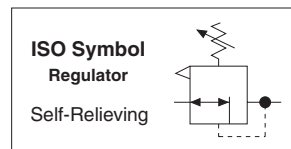

| Port Size | Dimensions inches (mm) | | | | Weight† lb (kg) |
|--------------------|------------------------|--------------|-----------|-------------|--------------------|
| | A | B* | C** | Depth† | |
| 1/4, 3/8, 1/2, 3/4 | 3.0 (76.2) | 4.52 (114.9) | 1.46 (37) | 2.51 (63.8) | 1.9 (0.86) |

* Dome removal clearance: add 0.575 (14.6).
** Cap removal clearance: add 0.750 (19.1).
† Less gauge.

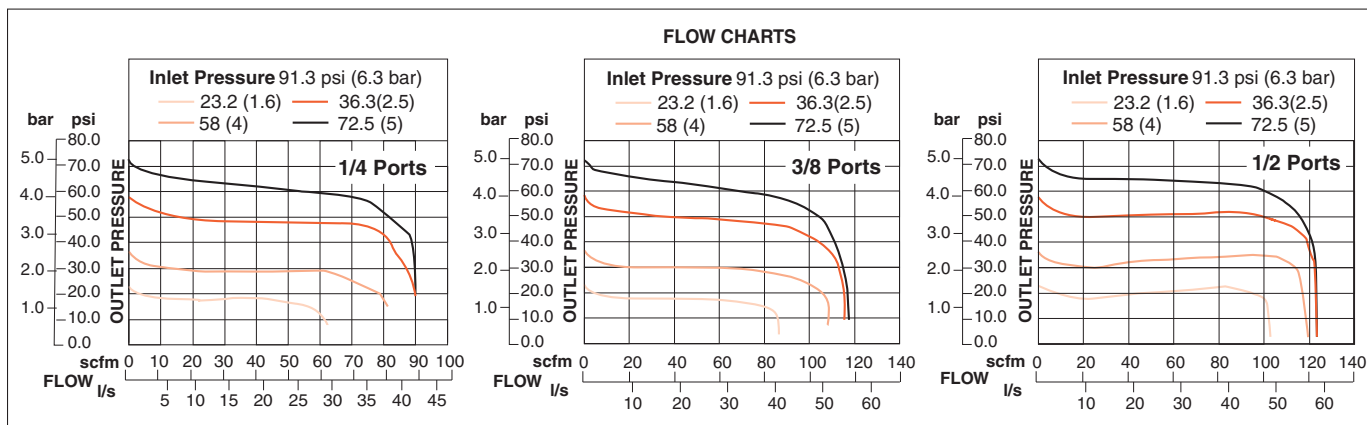

Accessories ordered separately, refer to page G6.3-5.

STANDARD SPECIFICATIONS (for regulators on this page):

| | | | |
|------------------------------|---|-----------------------|-----------------------------------|
| Construction Design | Diaphragm Self-relieving; For non-relieving option consult ROSS. | Panel Mounting | 2-1/16 inch (52 mm) hole required |
| Temperature | Ambient/Media: 40° to 175°F (4° to 79°C) | Construction Material | Body: Zinc |
| Fluid Media | Compressed air | | Dome: Nylon |
| Operating Pressure | Inlet: Maximum 300 psig (21 bar) Outlet: Adjustable up to 200 psig (14 bar); optional adjusting springs. | | Knob: Acetal |
| Optional Pressure Adjustment | Locking Key: Removable | | Seals: Nitrile |
| Pressure Gauge | 0-200 psig (0-14 bar) or 0-60 psig (0-4 bar); 1/4-NPT gauge ports front and rear | | Valve: Brass Valve Cap: Nylon |

IMPORTANT NOTE: Please read carefully and thoroughly all of the **CAUTIONS, WARNINGS** on the inside back cover.



Modular Regulators

FULL-SIZE Series

Port Sizes: 1/4, 3/8, 1/2 & 3/4 – Flow to 155 scfm

| Port Size | Pressure Range psig (bar) | | | | | |
|-----------|---------------------------|------------|---------------|------------|----------------|------------|
| | 0-50 (0-3.4) | | 0-125 (0-8.6) | | 0-175 (0-12.1) | |
| | Model Number | | Model Number | | Model Number | |
| | NPTF Threads | G Threads | NPTF Threads | G Threads | NPTF Threads | G Threads |
| 1/4 | 5212B2017 | C5212B2017 | 5211B2017 | C5211B2017 | 5213B2017 | C5213B2017 |
| 3/8 | 5212B3017 | C5212B3017 | 5211B3017 | C5211B3017 | 5213B3017 | C5213B3017 |
| 1/2 | 5212B4017 | C5212B4017 | 5211B4017 | C5211B4017 | 5213B4017 | C5213B4017 |
| 3/4 | 5212B5027 | C5212B5027 | 5211B5027 | C5211B5027 | 5213B5027 | C5213B5027 |



| REGULATORS with REVERSE FLOW | | | | | |
|------------------------------|-----------------------------------|------------|--------------|------------|------------|
| Port Size | Pressure Adjustment 0-125 (0-8.6) | | | | |
| | Knob | | T-Handle | | |
| | Model Number | | Model Number | | |
| | NPT Threads | G Threads | NPT Threads | G Threads | G Threads |
| 1/4 | 5X00B2010 | C5X00B2010 | – | – | – |
| 3/8 | 5X00B3004 | C5X00B3004 | 5X00B3012 | C5X00B3012 | C5X00B3012 |
| 1/2 | 5X00B4004 | C5X00B4004 | 5X00B4047 | C5X00B4047 | C5X00B4047 |
| 3/4 | 5X00B5034 | C5X00B5034 | 5X00B5044 | C5X00B5044 | C5X00B5044 |

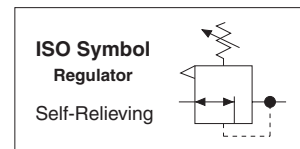

| Port Size | Dimensions inches (mm) | | | | Weight † lb (kg) |
|-----------------------|------------------------|-----------|----------|----------|---------------------|
| | A | B** | C*** | Depth † | |
| 1/4, 3/8, 1/2, 3/4 | 3.5 (89) | 5.8 (146) | 1.3 (33) | 2.8 (71) | 2.06 (0.92) |

** Dome removal clearance: add 0.63 (16).
*** Cap removal clearance: add 0.5 (13).
† Less gauge.

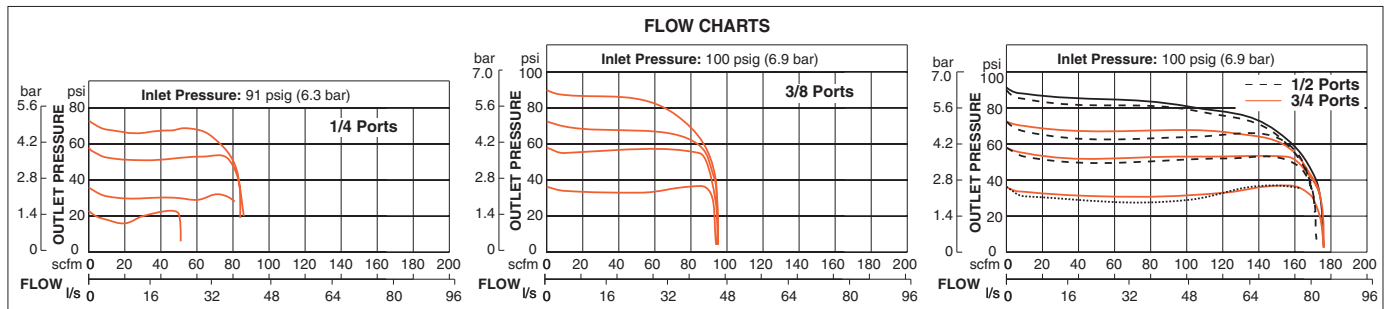

Pressure Gauge included.
Accessories ordered separately, refer to page G6.3-4.

STANDARD SPECIFICATIONS (for regulators on this page):

| | | | |
|------------------------------|---|-----------------------|--|
| Construction Design | Diaphragm Self-relieving; For non-relieving option consult ROSS. | Panel Mounting | 2-1/16 inch (52 mm) hole required |
| Temperature | Ambient/Media: 40° to 175°F (4° to 79°C) | Construction Material | Body: Zinc |
| Fluid Media | Compressed air | | Dome: Nylon; aluminum with optional 0 to 175 psig (0 to 12 bar) spring |
| Operating Pressure | Inlet: Maximum 300 psig (21 bar) Outlet: Adjustable up to 175 psig (12 bar); optional adjusting springs. | | Knob: Acetal |
| Optional Pressure Adjustment | Locking Key: Removable | | Seals: Nitrile |
| Pressure Gauge | 0-200 psig (0-14 bar); 1/4-NPT gauge ports front and rear | | Valve: Brass Valve Cap: Nylon |

IMPORTANT NOTE: Please read carefully and thoroughly all of the **CAUTIONS, WARNINGS** on the inside back cover.

Port Sizes: 3/8, 1/2 & 3/4 – Flow to 220 scfm

HOW TO ORDER

Choose your options (in red) to configure your model number.

MD4 **52K** **A** **S** **B** **5** **2** **B**

ADJUSTMENT TYPE

| | |
|------------|------------|
| Knob | 52K |
| Tee Handle | 52T |

ADJUSTMENT RANGE

| | |
|-------------------------|----------|
| 0-175 psig (0-12.1 bar) | A |
| 0-125 psig (0-8.6 bar) | B |
| 0-50 psig (0-3.4 bar) | C |
| 0-20 psig (0-1.4 bar) | D |

PIPE SIZE

| | |
|----------|----------|
| 3/8 NPTF | 3 |
| 1/2 NPTF | 4 |
| 3/4 NPTF | 5 |
| 3/8 G | C |
| 1/2 G | D |
| 3/4 G | E |

FLOW OPTIONS

| | |
|---------------|----------|
| Reverse Flow | R |
| Standard Flow | S |

CAP COLOR

| | |
|--------|----------|
| Black | 2 |
| Yellow | Y |

GAUGE

| | |
|---|----------|
| Without Gauge | A |
| Gauge 0-200 psig (0-13.8 bar) | B |
| Gauge 0-60 psig (0-4.1 bar) | C |
| Without Gauge, with Panel Mount Nut | D |
| Gauge 0-200 psig (0-13.8 bar), with Panel Mount Nut | E |
| Gauge 0-60 psig (0-4.1 bar), with Panel Mount Nut | F |



ISO Symbol
Regulator
Self-Relieving

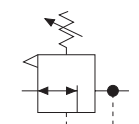

| Port Size | Dimensions inches (mm) | | | | Weight † lb (kg) |
|---------------|------------------------|-----------|----------|----------|---------------------|
| | A | B* | C** | Depth † | |
| 3/8, 1/2, 3/4 | 3.5 (87) | 5.6 (142) | 1.6 (40) | 2.9 (73) | 2.56 (1.16) |

*Dome removal clearance: add 0.625 (16).

**Cap removal clearance: add 0.50 (13).

† Dimensions reflect less gauge.

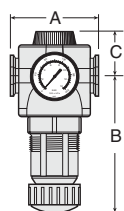

FLOW CHARTS

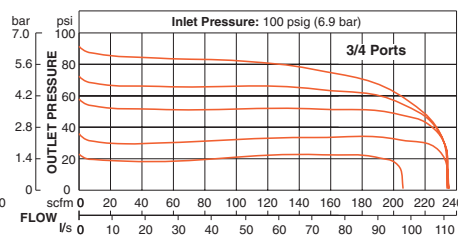
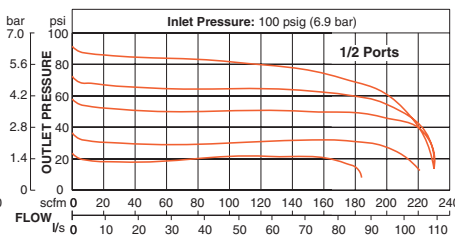
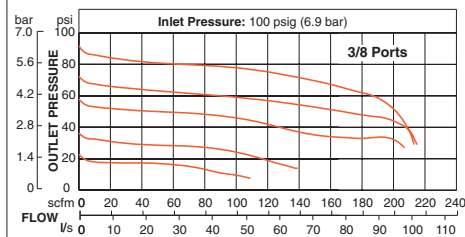

Accessories ordered separately, refer to page G6.3-5.

STANDARD SPECIFICATIONS (for regulators on this page):

| | | | |
|------------------------------|---|-----------------------|--|
| Construction Design | Diaphragm Self-relieving; For non-relieving option consult ROSS. | Panel Mounting | 2-1/16 inch (52 mm) hole required |
| Temperature | Ambient/Media: 40° to 175°F (4° to 79°C) | Construction Material | Body: Zinc |
| Fluid Media | Compressed air | | Dome: Nylon; aluminum with optional 0 to 175 psig (0 to 12 bar) spring |
| Operating Pressure | Inlet: Maximum 300 psig (21 bar) Outlet: Adjustable up to 175 psig (12 bar); optional adjusting springs. | | Knob: Acetal |
| Optional Pressure Adjustment | Locking Key: Removable | | Seals: Nitrile |
| Pressure Gauge | 0-200 psig (0-14 bar); 1/4-NPT gauge ports front and rear | | Valve: Brass |
| | | | Valve Cap: Nylon |

IMPORTANT NOTE: Please read carefully and thoroughly all of the **CAUTIONS, WARNINGS** on the inside back cover.



Online Version
02/01/21



www.rosscontrols.com

In-line Regulators

HIGH-CAPACITY Series

Port Sizes: 3/4, 1, 1¼ & 1½ – Flow to 800 scfm

| Port Size | Pressure Range psig (bar) | | | |
|-----------|---------------------------|------------|---------------|------------|
| | 0-50 (0-3.4) | | 0-100 (0-6.9) | |
| | Model Number | | Model Number | |
| | NPTF Threads | G Threads | NPTF Threads | G Threads |
| 3/4 | 5212D5017 | C5212D5017 | 5211D5017 | C5211D5017 |
| 1 | 5212D6017 | C5212D6017 | 5211D6017 | C5211D6017 |
| 1¼ | 5212C7017 | C5212C7017 | 5211C7017 | C5211C7017 |
| 1½ | 5212C8017 | C5212C8017 | 5211C8017 | C5211C8017 |



| REGULATORS with REVERSE FLOW: | | | | | |
|-------------------------------|---------------------------|---------------------|------------|--------------|------------|
| Port Size | Pressure Range psig (bar) | Pressure Adjustment | | | |
| | | Knob | | T-Handle | |
| | | Model Number | | Model Number | |
| | | NPTF Threads | G Threads | NPTF Threads | G Threads |
| 3/4 | 0-100 (0-6.9) | 5X00B5049 | C5X00B5049 | 5X00B5050 | C5X00B5050 |
| 1 | 0-100 (0-6.9) | 5X00D6003 | C5X00D6003 | 5X00B6038 | C5X00B6038 |
| 1¼ | 0-100 (0-6.9) | 5X00C7003 | C5X00C7003 | 5X00B7016 | C5X00B7016 |
| 1½ | 0-100 (0-6.9) | 5X00C8001 | C5X00C8001 | 5X00B8024 | C5X00B8024 |

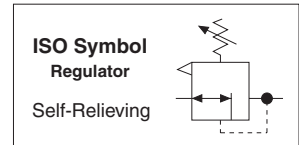

| Port Size | Dimensions inches (mm) | | | | Weight † lb (kg) |
|-----------|------------------------|-----------|----------|----------|---------------------|
| | A | B** | C*** | Depth † | |
| 3/4, 1 | 4.4 (111) | 6.1 (154) | 2.4 (62) | 2.8 (71) | 2.19 (0.99) |
| 1¼, 1½ | 4.9 (124) | 6.4 (162) | 2.1 (54) | 2.8 (71) | 2.50 (1.14) |

** Dome removal clearance: add 0.63 (16).
*** Cap removal clearance: add 0.65 (16.5).
† Dimensions reflect less gauge.

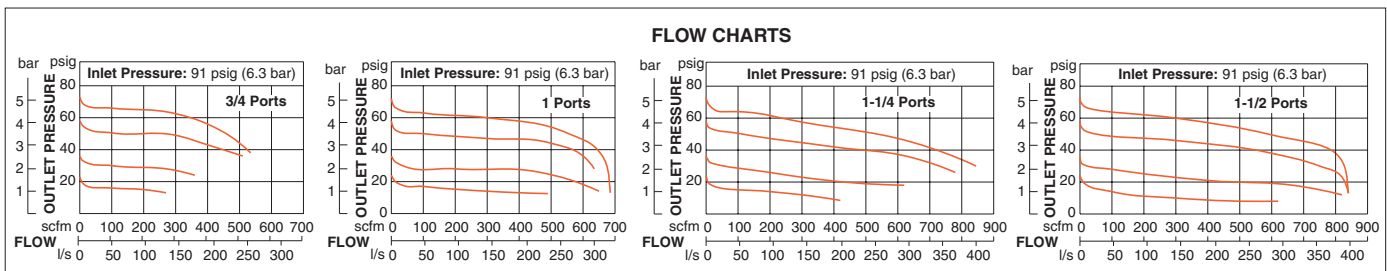

Pressure Gauge included.
Accessories ordered separately, refer to page G6.3-4.

STANDARD SPECIFICATIONS (for regulators on this page):

| | | | |
|------------------------------|---|-----------------------|--|
| Construction Design | Piston Self-relieving | Construction Material | Body: Aluminum |
| Temperature | Ambient/Media: 40° to 175°F (4° to 79°C) | | Dome: Nylon; aluminum with optional 0 to 150 psig (0 to 10 bar) spring |
| Fluid Media | Compressed air | | Knob: Acetal |
| Operating Pressure | Inlet: Maximum 300 psig (21 bar) Outlet: Adjustable up to 100 psig (7 bar) | | Seals: Nitrile |
| Optional Pressure Adjustment | Locking Key: Removable | | Valve: Brass |
| Pressure Gauge | 0-200 psig (0-14 bar); 1/4-NPT gauge ports front and rear | | Valve Cap: Nylon |
| Panel Mounting | 2-1/16 inch (52 mm) hole required | | |

IMPORTANT NOTE: Please read carefully and thoroughly all of the **CAUTIONS, WARNINGS** on the inside back cover.

In-line High-Pressure Regulators

HIGH-PRESSURE Series

Port Sizes: 1/8, 1/4 & 3/8 – Flow to 70 scfm

| Port Size | Piston Type | | | |
|-----------|--------------|------------|---------------|------------|
| | Relieving | | Non-Relieving | |
| | Model Number | | Model Number | |
| | NPTF Threads | G Threads | NPTF Threads | G Threads |
| 1/8 | 5215B1004 | C5215B1004 | 5X00B1025 | C5X00B1025 |
| 1/4 | 5215B2004 | C5215B2004 | 5X00B2076 | C5X00B2076 |
| 3/8 | 5215B3004 | C5215B3004 | 5X00B3052 | C5X00B3052 |



| Port Size | Dimensions inches (mm) | | | | Weight** lb (kg) |
|-----------|------------------------|---------------|----------|----------|---------------------|
| | A | B | C | Depth** | |
| 1/8, 1/4 | 1.9 (47) | 7.3 (186) max | 0.4 (10) | 1.9 (47) | 1.15 (0.53) |
| 3/8 | 2.1 (54) | 7.4 (188) max | 0.5 (13) | 2.1 (54) | 1.30 (0.59) |

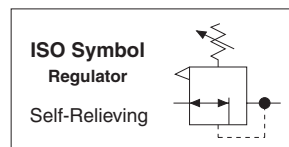
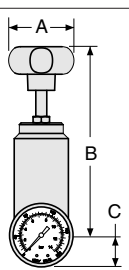

** Less gauge.

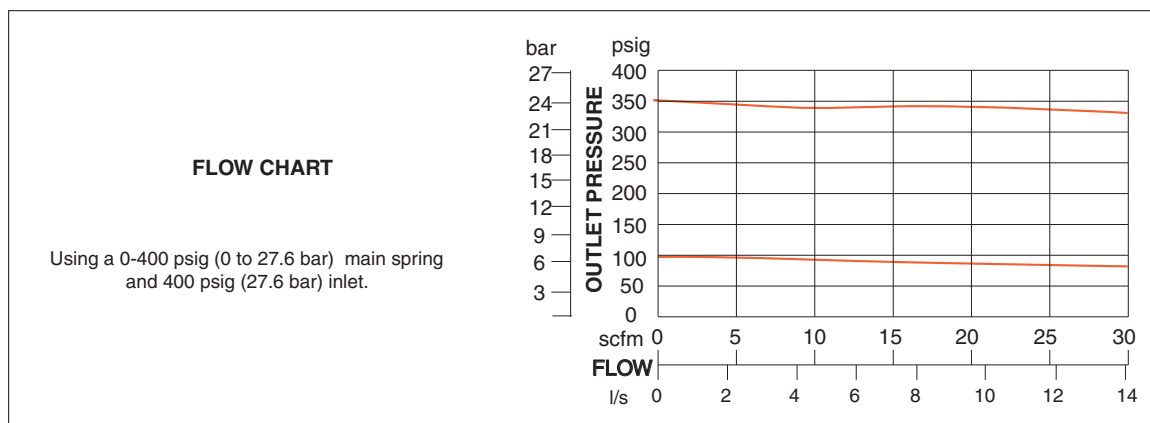

Pressure Gauge included.
Accessories ordered separately, refer to page G6.3-4.

STANDARD SPECIFICATIONS (for regulators on this page):

| | | | |
|---------------------|--|-----------------------|--------------------------------------|
| Construction Design | Piston Self-relieving, Non-relieving | Maximum Flow Rate | 70 scfm (33.0 l/s) @400 psi (28 bar) |
| Temperature | Ambient/Media: 40° to 175°F (4° to 79°C) | Construction Material | Body: Aluminum |
| Fluid Media | Compressed air | | Dome: Aluminum |
| Operating Pressure | Inlet: Maximum 400 psig (28 bar) Outlet: Adjustable up to 390 psig (27 bar) | | Knob: Nylon |
| Pressure Gauge | 0-600 psig (0-40 bar) | | Seals: Fluoroelastomer |
| | | | Valve: Brass Valve Cap: Nylon |

IMPORTANT NOTE: Please read carefully and thoroughly all of the **CAUTIONS, WARNINGS** on the inside back cover.



Online Version
02/01/21



www.rosscontrols.com

G2.11

In-line Precision Regulators

MINIATURE Series

Port Sizes: 1/8 & 1/4 – Flow to 4 scfm

| Port Size | Regulated Pressure Range# psig (bar) | Model Number | |
|-----------|---|--------------|------------|
| | | NPTF Threads | G Threads |
| 1/8 | 0-50 (0-3.4) | 5212C1006 | C5212C1006 |
| 1/4 | 0-50 (0-3.4) | 5212C2006 | C5212C2006 |

For 0-10 psig (0-0.7 bar), 0-20 psig (0-1.4 bar), and 0-60 psig (0-4.1 bar) ranges, consult ROSS.



| Port Size | Dimensions inches (mm) | | | | Weight** lb (kg) |
|-----------|------------------------|----------|----------|----------|---------------------|
| | A | B | C | Depth** | |
| 1/8, 1/4 | 1.8 (44) | 3.4 (86) | 0.4 (10) | 1.8 (44) | 0.38 (0.16) |

**Less gauge.

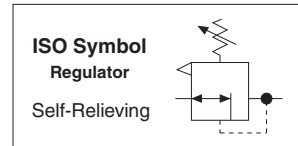
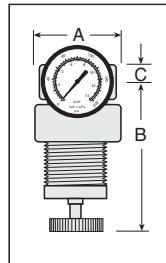

Precision Regulators have a small valve seat and a large diaphragm area, a combination that allows greater precision, sensitivity, adjustment resolution, and less variation in regulated pressure.

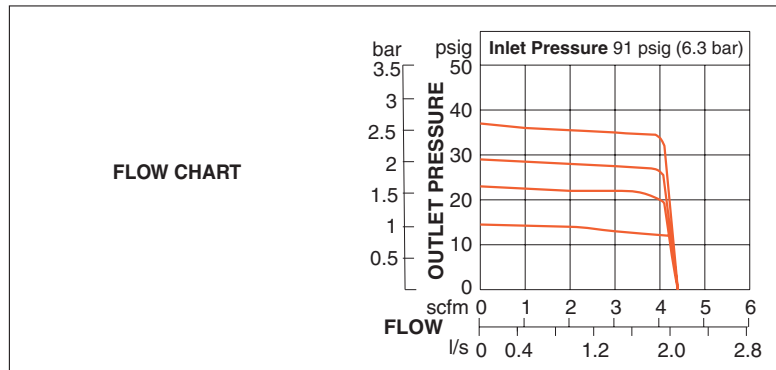

Accessories ordered separately, refer to page G6.3-4.

STANDARD SPECIFICATIONS (for regulators on this page):

| | | | |
|---------------------|---|-----------------------|-----------------------------------|
| Construction Design | Diaphragm Self-relieving | Panel Mounting | 1-3/16 inch (30 mm) hole required |
| Temperature | Ambient/Media: 40° to 125°F (4° to 52°C) | Construction Material | Body: Aluminum |
| Fluid Media | Compressed air | | Dome: Acetal |
| Operating Pressure | Inlet: Maximum 300 psig (21 bar) Outlet: Adjustable up to 100 psig (7 bar) | | Knob: Acetal |
| Pressure Gauge | 0-160 psig (0-11 bar); 1/8-NPT gauge ports front and rear | | Seals: Nitrile |

IMPORTANT NOTE: Please read carefully and thoroughly all of the **CAUTIONS, WARNINGS** on the inside back cover.

Port Sizes: 1/4, 3/8, 1/2 & 3/4 – Flow to 155 scfm



| Internally Piloted Regulator | | | | |
|------------------------------|---------------------------|------------|-----------------|------------|
| Port Size | Pressure Range psig (bar) | | | |
| | 15-200 (1-13.8) | | 15-250 (1-17.2) | |
| | Model Number | | Model Number | |
| | NPTF Threads | G Threads | NPT F Threads | G Threads |
| 1/4 | 5213C2018 | C5213C2018 | 5214C2018 | C5214C2018 |
| 3/8 | 5213C3018 | C5213C3018 | 5214C3018 | C5214C3018 |
| 1/2 | 5213C4018 | C5213C4018 | 5214C4018 | C5214C4018 |
| 3/4 | 5213C5018 | C5213C5018 | 5214C5018 | C5214C5018 |

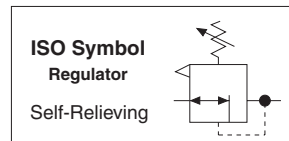

| Port Size | Dimensions inches (mm) | | | | Weight† lb (kg) |
|--------------------|------------------------|-----------|----------|----------|--------------------|
| | A | B** | C*** | Depth† | |
| 1/4, 3/8, 1/2, 3/4 | 3.5 (89) | 4.2 (106) | 1.3 (33) | 2.8 (71) | 2.06 (0.92) |

** Dome removal clearance: add 0.63 (16).
*** Cap removal clearance: add 0.5 (13).
† Less gauge.

Precision internal Pilot Regulators provide improved torque control for pneumatic tools; diaphragm type. Pressure settings held within 3 psig (0.2 bar).

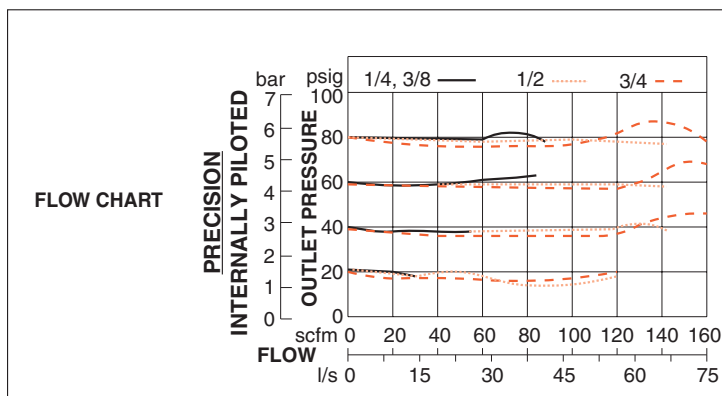

*Pressure Gauge included.
Accessories ordered separately, refer to page G6.3-4.*

STANDARD SPECIFICATIONS (for regulators on this page):

| | | | |
|------------------------------|---|-----------------------|--|
| Construction Design | Diaphragm Self-relieving | Panel Mounting | 2-1/16 inch (52 mm) hole required |
| Temperature | Ambient/Media: 40° to 125°F (4° to 52°C) | Construction Material | Body: Zinc |
| Fluid Media | Compressed air | | Dome: Nylon; Aluminum with optional 0 to 175 psig (0 to 12 bar) spring |
| Operating Pressure | Inlet: Maximum 300 psig (21 bar) Outlet: Adjustable 15 to 250 psig (1 to 17 bar) | | Knob: Acetal |
| Optional Pressure Adjustment | Locking Key: Removable | | Seals: Nitrile |
| Pressure Gauge | 0 to 200 psig (0 to 14 bar); 1/4 NPT gauge ports front and rear | | Valve: Brass Valve Cap: Nylon |

IMPORTANT NOTE: Please read carefully and thoroughly all of the **CAUTIONS, WARNINGS** on the inside back cover.



Modular Precision Regulators

MD4™ Series

Port Sizes: 3/8, 1/2 & 3/4 – Flow to 170 scfm

Choose your options (in red) to configure your model number.

MD4 **52K** **E** **B** **5** **2** **B**

| ADJUSTMENT RANGE | |
|----------------------------|----------|
| 15-200 psig (1.0-13.8 bar) | E |
| 15-250 psig (1.0-17.2bar) | F |
| 15-100 psig (1.0-6.9 bar) | G |

| PIPE SIZE | |
|-----------|----------|
| 3/8 NPTF | 3 |
| 1/2 NPTF | 4 |
| 3/4 NPTF | 5 |
| 3/8 G | C |
| 1/2 G | D |
| 3/4 G | E |

| GAUGE | |
|---|----------|
| Without Gauge | A |
| Gauge 0-200 psig (0-13.8 bar) | B |
| Without Gauge, with Panel Mount Nut | D |
| Gauge 0-200 psig (0-13.8 bar), with Panel Mount Nut | E |

| CAP COLOR | |
|-----------|----------|
| Black | 2 |
| Yellow | Y |

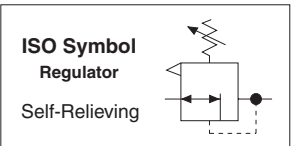

| Port Size | Dimensions inches (mm) | | | | Weight † lb (kg) |
|---------------|------------------------|-----------|----------|----------|---------------------|
| | A | B | C | Depth † | |
| 3/8, 1/2, 3/4 | 3.5 (87) | 4.8 (122) | 1.6 (40) | 2.9 (73) | 2.3 (1.0) |

† Dimensions reflect less gauge.

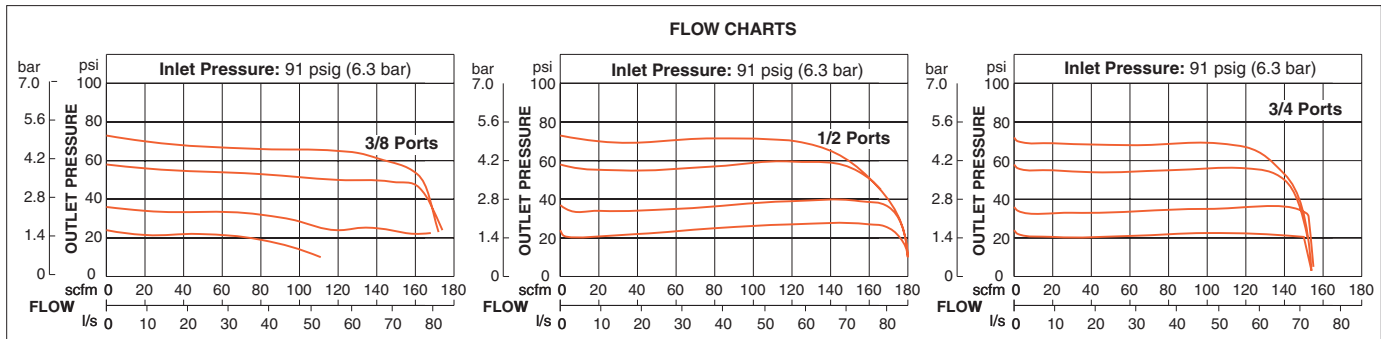
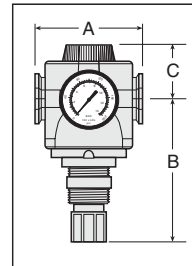

Accessories ordered separately, refer to page G6.3-5.

STANDARD SPECIFICATIONS (for regulators on this page):

| | | | |
|---------------------|---|-----------------------|---|
| Construction Design | Diaphragm Self-relieving | Construction Material | Body: Zinc |
| Temperature | Ambient/Media: 40° to 125°F (4° to 52°C) | | Bonnet and Knob: Acetal |
| Fluid Media | Compressed air | | Dome: Zinc |
| Operating Pressure | Inlet: Maximum 250 psig (17 bar) Outlet: Adjustable 15 to 250 psig (1 to 17 bar) | | Seals: Nitrile |
| Pressure Gauge | 0 to 200 psig (0 to 14 bar); 1/4 NPT gauge ports front and rear | | Valve: Brass |
| Panel Mounting | 2-1/16 (52 mm) hole required | | Precision Regulators: Provide improved torque control for pneumatic tools; diaphragm type. Pressure settings held within 3 psig (0.2 bar) |

IMPORTANT NOTE: Please read carefully and thoroughly all of the **CAUTIONS, WARNINGS** on the inside back cover.

In-line Precision Regulators

HIGH-CAPACITY Series

Port Sizes: 3/4, 1, 1¼, 1½ – Flow to 800 scfm

| Port Size | Pressure Range psig (bar) | | | |
|-----------|---------------------------|------------|-----------------|------------|
| | 15-200 (1-13.8) | | 15-250 (1-17.2) | |
| | Model Number | | Model Number | |
| | NPTF Threads | G Threads | NPTF Threads | G Threads |
| 3/4 | 5213D5017 | C5213D5017 | 5214D5017 | C5214D5017 |
| 1 | 5213D6017 | C5213D6017 | 5214D6017 | C5214D6017 |
| 1¼ | 5213D7017 | C5213D7017 | 5214D7017 | C5214D7017 |
| 1½ | 5213D8017 | C5213D8017 | 5214D8017 | C5214D8017 |

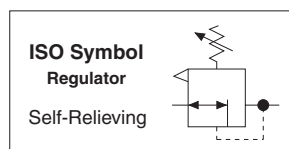

| Port Size | Dimensions inches (mm) | | | | Weight † lb (kg) |
|-----------|------------------------|-----------|----------|----------|---------------------|
| | A | B | C | Depth † | |
| 3/4, 1 | 4.4 (111) | 4.6 (112) | 2.4 (62) | 2.8 (71) | 2.0 (0.91) |
| 1¼, 1½ | 4.9 (124) | 4.9 (125) | 2.1 (54) | 2.8 (71) | 2.38 (1.08) |

† Dimensions reflect less gauge.

FLOW CHARTS

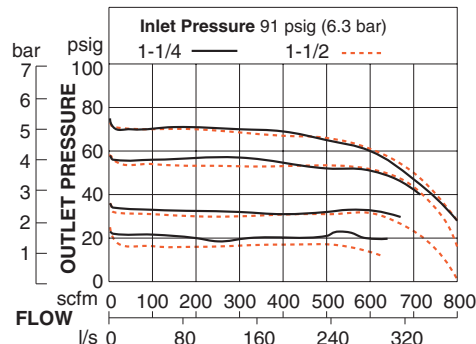
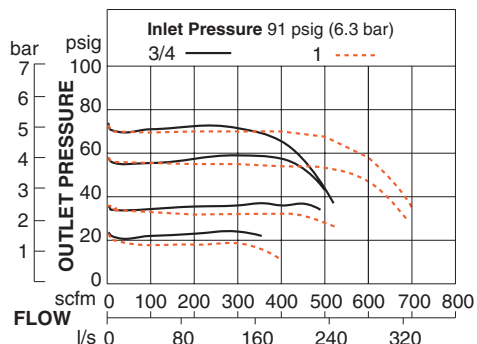

Precision Regulators:

Provide improved torque control for pneumatic tools. Pressure settings held within 3 psig (0.2 bar).

Pressure Gauge included.

Accessories ordered separately, refer to page G6.3-4.

STANDARD SPECIFICATIONS (for regulators on this page):

| | | | |
|---------------------|---|-----------------------|-------------------------|
| Construction Design | Diaphragm Self-relieving | Construction Material | Body: Aluminum |
| Temperature | Ambient/Media: 40° to 175°F (4° to 79°C) | | Bonnet and Knob: Acetal |
| Fluid Media | Compressed air | | Dome: Zinc |
| Operating Pressure | Inlet: Maximum 300 psig (21 bar) Outlet: Adjustable 15 to 250 psig (1 to 17 bar) | | Seals: Nitrile |
| Pressure Gauge | 0 to 200 psig (0 to 14 bar); 1/4 NPT gauge ports front and rear | | Valve: Brass |
| Panel Mounting | 1-3/16 (30 mm) hole required | | Valve Cap: Nylon |

IMPORTANT NOTE: Please read carefully and thoroughly all of the **CAUTIONS, WARNINGS** on the inside back cover.



Online Version
02/01/21



www.rosscontrols.com

G2.15

Port Sizes: 1/4, 3/8, 1/2, 3/4 – Flow to 155 scfm

| Port Size | Pressure Range psig (bar) | |
|-----------|---------------------------|------------|
| | 0-200 (0-13.8) | |
| | Model Number | |
| | NPTF Threads | G Threads |
| 1/4 | 5211C2007 | C5211C2007 |
| 3/8 | 5211C3007 | C5211C3007 |
| 1/2 | 5211C4007 | C5211C4007 |
| 3/4 | 5211C5007 | C5211C5007 |

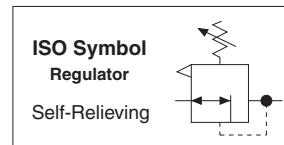

| Port Size | Dimensions inches (mm) | | | | Weight† lb (kg) |
|--------------------|------------------------|----------|----------|----------|--------------------|
| | A | B** | C*** | Depth† | |
| 1/4, 3/8, 1/2, 3/4 | 3.5 (89) | 2.4 (62) | 1.3 (33) | 2.8 (71) | 2.06 (0.92) |

** Dome removal clearance: add 0.63 (16).
*** Cap removal clearance: add 0.5 (13).
† Less gauge.

Remote Pilot Regulators use any small regulator to provide remote adjustment and to ensure accurate pressure control.

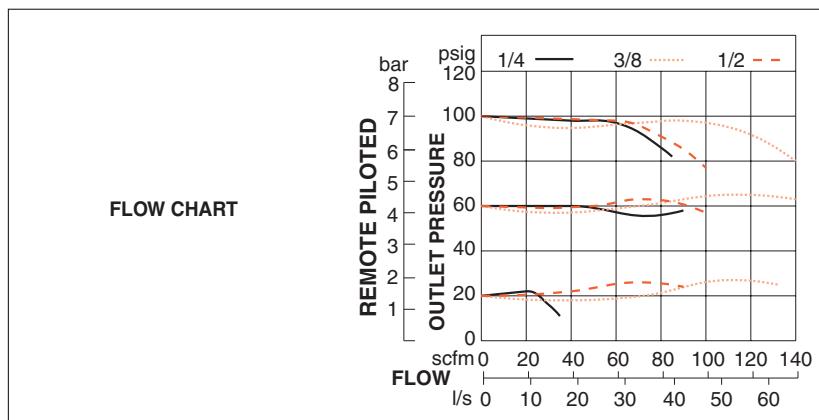

Pressure Gauge included.
Accessories ordered separately, refer to page G6.3-4.

STANDARD SPECIFICATIONS (for regulators on this page):

| | | | |
|---------------------|---|-----------------------|------------------|
| Construction Design | Diaphragm Self-relieving | Construction Material | Body: Zinc |
| Temperature | Ambient/Media: 40° to 125°F (4° to 52°C) | | Dome: Zinc |
| Fluid Media | Compressed air | | Knob: Acetal |
| Operating Pressure | Inlet: Maximum 300 psig (21 bar) Outlet: Adjustable 15 to 250 psig (1 to 17 bar) | | Seals: Nitrile |
| Pressure Gauge | 0 to 200 psig (0 to 14 bar); 1/4 NPT gauge ports front and rear | | Valve: Brass |
| Panel Mounting | 2-1/16 inch (52 mm) hole required | | Valve Cap: Nylon |

IMPORTANT NOTE: Please read carefully and thoroughly all of the **CAUTIONS, WARNINGS** on the inside back cover.

Modular Remote High-Relief Pilot Regulators

FULL-SIZE Series

Port Sizes: 1/4, 3/8, 1/2 & 3/4 – Flow to 150 scfm

| Port Size | Model Number | |
|-----------|--------------|------------|
| | NPTF Threads | G Threads |
| 1/4 | 5X00B2037 | C5X00B2037 |
| 3/8 | 5X00B3025 | C5X00B3025 |
| 1/2 | 5X00B4040 | C5X00B4040 |
| 3/4 | 5X00B5035 | C5X00B5035 |

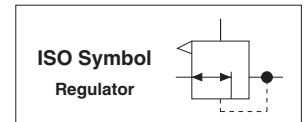

| Port Size | Dimensions inches (mm) | | | | Weight † lb (kg) |
|--------------------|------------------------|----------|----------|----------|---------------------|
| | A | B | C | Depth † | |
| 1/4, 3/8, 1/2, 3/4 | 3.5 (87) | 2.4 (62) | 1.3 (33) | 2.8 (71) | 2.06 (0.92) |

† Dimensions reflect less gauge.

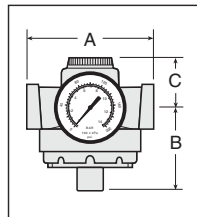

FLOW CHARTS

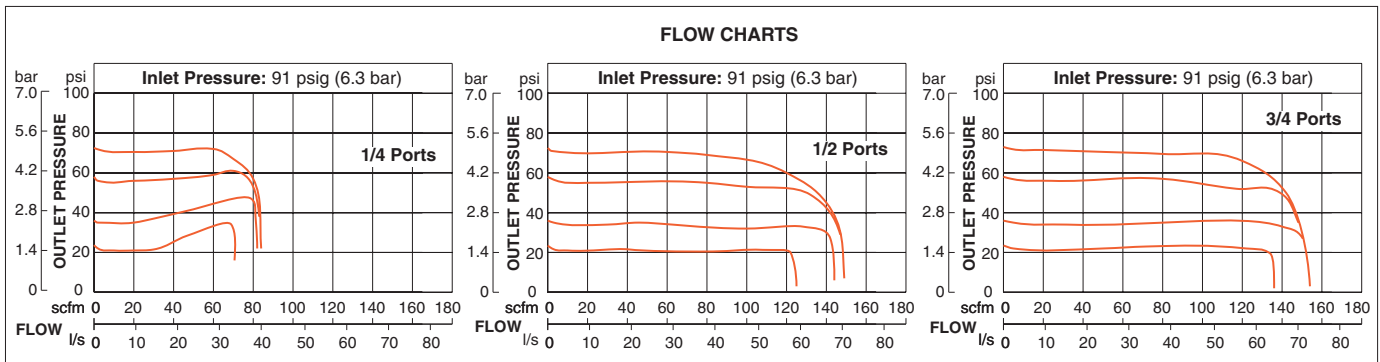

Pressure Gauge included.
Accessories ordered separately, refer to page G6.3-4.

STANDARD SPECIFICATIONS (for regulators on this page):

| | | | |
|---------------------|---|-----------------------|--|
| Construction Design | Diaphragm Self-relieving | Panel Mounting | 2-1/16 inch (52 mm) hole required |
| Temperature | Ambient/Media: 40° to 175°F (4° to 79°C) | Construction Material | Body: Zinc |
| Fluid Media | Compressed air | | Dome: Zinc |
| Operating Pressure | Inlet: Maximum 300 psig (21 bar) Outlet: Adjustable 15 to 200 psig (1 to 14 bar) | | Seals: Nitrile; Fluoroelastomer seals optional, consult ROSS |
| Pressure Gauge | 0 to 200 psig (0 to 14 bar); 1/4 NPT gauge ports front and rear | | Valve: Brass |
| Pilot Ports | 1/4 NPTF | | Valve Cap: Nylon |

IMPORTANT NOTE: Please read carefully and thoroughly all of the **CAUTIONS, WARNINGS** on the inside back cover.



Online Version
02/01/21



www.rosscontrols.com

In-line Premium High-Relief Remote Pilot Regulators

FULL-SIZE Series

Port Sizes: 1/4, 3/8 & 1/2 – Flow to 150 scfm

| Port Size | Model Number | |
|-----------|--------------|------------|
| | NPTF Threads | G Threads |
| 1/4 | 5216A2007 | C5216A2007 |
| 3/8 | 5216A3007 | C5216A3007 |
| 1/2 | 5216A4007 | C5216A4007 |



| Port Size | Dimensions inches (mm) | | | | Weight† lb (kg) |
|---------------|------------------------|-------------|-------------|------------|--------------------|
| | A | B** | C*** | Depth† | |
| 1/4, 3/8, 1/2 | 4.18 (106) | 1.54 (39.1) | 3.52 (89.3) | 4.18 (106) | 4.84 (2.2) |

** Dome removal clearance: add 0.63 (16).

*** Cap removal clearance: add 0.5 (13).

† Less gauge.

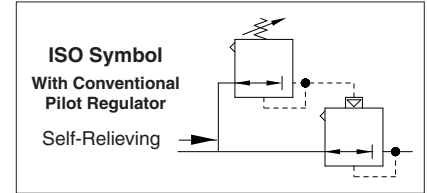
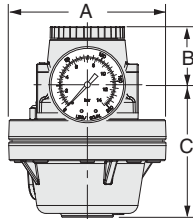

FLOW CHARTS

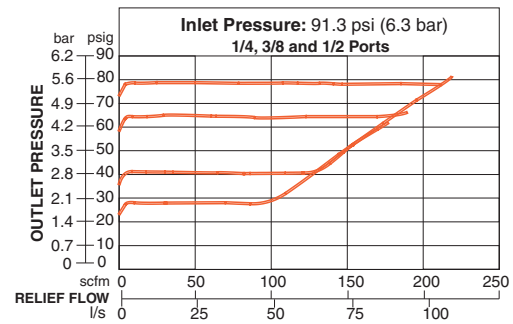
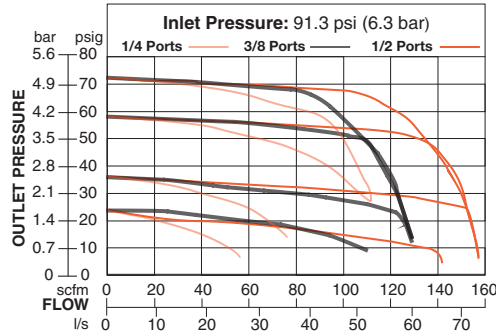

Pressure Gauge included.
Accessories ordered separately, refer to page G6.3-4.

STANDARD SPECIFICATIONS (for regulators on this page):

| | | | |
|---------------------|--|-------------------------------|---|
| Construction Design | Diaphragm Self-relieving | Pressure Gauge | 0 to 200 psig (0 to 14 bar) standard, 1/4-NPTF (1/4 BSPP) gauge ports front and rear; 0 to 600 psig (0 to 40 bar) optional |
| Temperature | Ambient/Media: 0° to 158°F (-18° to 70°C) | | Construction Material |
| Fluid Media | Compressed air | Dome: Zinc | |
| Operating Pressure | Inlet: Maximum 400 psig (28 bar) | Seals: Nitrile | |
| | Outlet: Adjustable up to 250 psig (17 bar) | Valve: Brass | |
| | | Valve Cap: Glass filled Nylon | |

IMPORTANT NOTE: Please read carefully and thoroughly all of the **CAUTIONS, WARNINGS** on the inside back cover.

Modular Remote Pilot Regulators

MD4™ Series

Port Sizes: 3/8, 1/2 & 3/4 – Flow to 190 scfm

Choose your options (in red) to configure your model number.

MD4 52K 1 B 5 2 B

| RELIEF OPTION | |
|---------------|---|
| Relieving | 1 |
| Non-relieving | 2 |

| PIPE SIZE | |
|-----------|---|
| 3/8 NPTF | 3 |
| 1/2 NPTF | 4 |
| 3/4 NPTF | 5 |
| 3/8 G | C |
| 1/2 G | D |
| 3/4 G | E |

| CAP COLOR | |
|-----------|---|
| Black | 2 |
| Yellow | Y |

| GAUGE | |
|-------------------------------|---|
| Without Gauge | A |
| Gauge 0-200 psig (0-13.8 bar) | B |

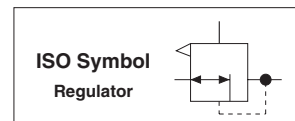

| Port Size | Dimensions inches (mm) | | | | Weight † lb (kg) |
|--------------------|------------------------|----------|----------|----------|---------------------|
| | A | B | C | Depth † | |
| 1/4, 3/8, 1/2, 3/4 | 3.5 (87) | 2.4 (62) | 1.6 (41) | 2.9 (73) | 2.2 (1.0) |

† Dimensions reflect less gauge.

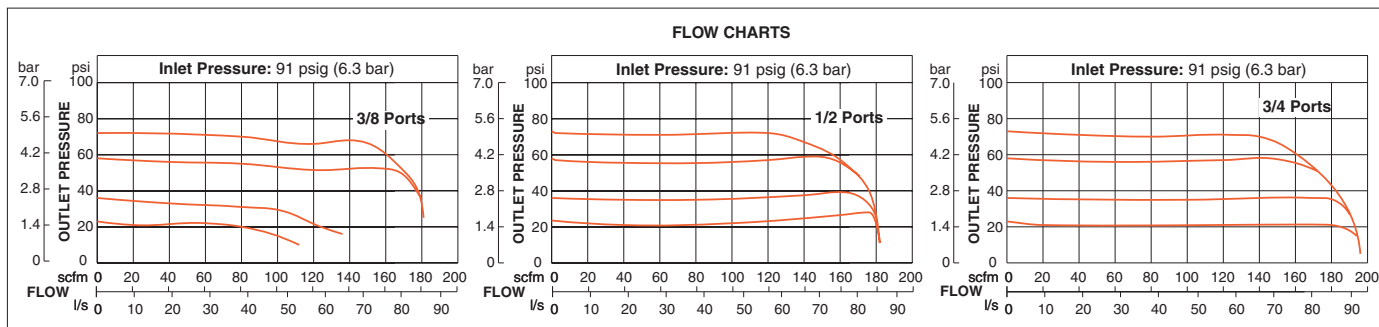
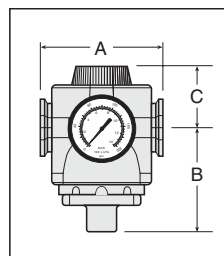

Accessories ordered separately, refer to page G6.3-5.

STANDARD SPECIFICATIONS (for regulators on this page):

| | | | |
|---------------------|--|-----------------------|---|
| Construction Design | Diaphragm Self-relieving | Pressure Gauge | 0 to 200 psig (0 to 14 bar) standard, 1/4-NPTF (1/4 BSPP) gauge ports front and rear; |
| Temperature | Ambient/Media: 40° to 175°F (4° to 79°C) | Construction Material | Body: Zinc |
| Fluid Media | Compressed air | | Dome: Zinc |
| Operating Pressure | Inlet: Maximum 300 psig (21 bar) | | Seals: Nitrile |
| | Outlet: Adjustable 0 to 250 psig (0 to 17 bar) | | Valve: Brass |
| | | Valve Cap: Nylon | |

IMPORTANT NOTE: Please read carefully and thoroughly all of the **CAUTIONS, WARNINGS** on the inside back cover.



Online Version
02/01/21



www.rosscontrols.com

G2.19

In-line Remote Pilot Regulators

HIGH-CAPACITY Series

Port Sizes: 3/4, 1, 1¼ & 1½– Flow to 740 scfm

| Port Size | Model Number | |
|-----------|--------------|------------|
| | NPTF Threads | G Threads |
| 3/4 | 5211D5006 | C5211D5006 |
| 1 | 5211D6007 | C5211D6007 |
| 1¼ | 5211D7007 | C5211D7007 |
| 1½ | 5211D8007 | C5211D8007 |



| Port Size | Dimensions inches (mm) | | | | Weight† lb (kg) |
|-----------|------------------------|----------|----------|----------|--------------------|
| | A | B* | C** | Depth† | |
| 3/4, 1 | 4.4 (111) | 2.9 (74) | 2.4 (62) | 2.8 (71) | 1.88 (0.85) |
| 1¼, 1½ | 4.9 (124) | 3.2 (81) | 2.1 (54) | 2.8 (71) | 2.25 (1.02) |

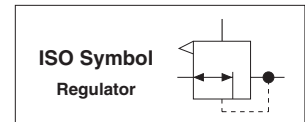
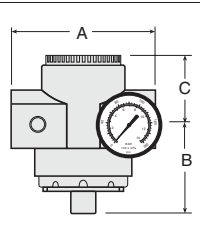

† Less gauge.

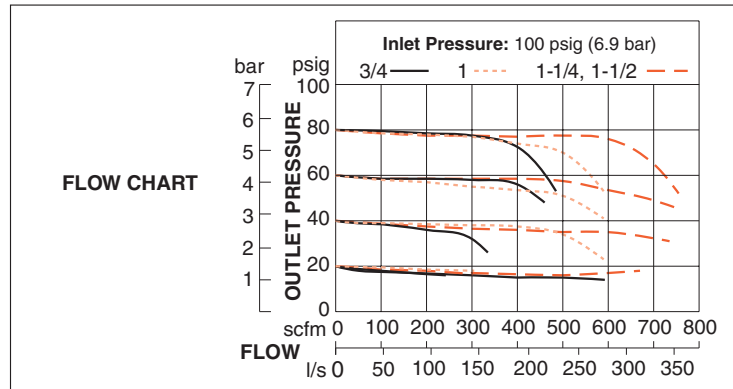

Pressure Gauge included.

Accessories ordered separately, refer to page G6.3-4.

STANDARD SPECIFICATIONS (for regulators on this page):

| | | | |
|---------------------|--|-----------------------|---|
| Construction Design | Diaphragm Self-relieving | Pressure Gauge | 0 to 200 psig (0 to 14 bar) standard, 1/4-NPTF gauge ports front and rear |
| Temperature | Ambient/Media: 40° to 175°F (4° to 79°C) | Construction Material | Body: Aluminum |
| Fluid Media | Compressed air | | Dome: Zinc |
| Operating Pressure | Inlet: Maximum 300 psig (21 bar) Outlet: Adjustable 0 to 200 psig (0 to 14 bar) NOTE: Outlet pressure depends on the adjustment of the pilot regulator | | Seals: Nitrile |
| | Pilot Ports | | 1/4-NPTF |

IMPORTANT NOTE: Please read carefully and thoroughly all of the **CAUTIONS, WARNINGS** on the inside back cover.

In-line High-Relief Remote Pilot Regulators

HIGH-CAPACITY Series

Port Sizes: 3/4, 1, 1¼ & 1½ – Flow to 700 scfm

| Port Size | Model Number | |
|-----------|--------------|------------|
| | NPTF Threads | G Threads |
| 3/4 | 5X00B5046 | C5X00B5046 |
| 1 | 5X00B6039 | C5X00B6039 |
| 1¼ | 5X00B7021 | C5X00B7021 |
| 1½ | 5X00B8049 | C5X00B8049 |



| Port Size | Dimensions inches (mm) | | | | Weight† lb (kg) |
|-----------|------------------------|----------|----------|----------|--------------------|
| | A | B** | C*** | Depth† | |
| 3/4, 1 | 4.4 (111) | 2.9 (74) | 2.4 (62) | 2.8 (71) | 1.88 (0.85) |
| 1¼, 1½ | 4.9 (124) | 3.2 (81) | 2.1 (54) | 2.8 (71) | 2.25 (1.02) |

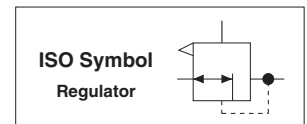
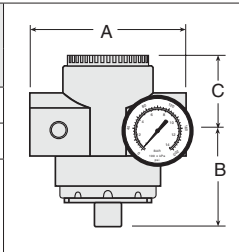

** Dome removal clearance: add 0.63 (16).
 *** Cap removal clearance: add 0.5 (13).
 † Less gauge.

FLOW CHARTS

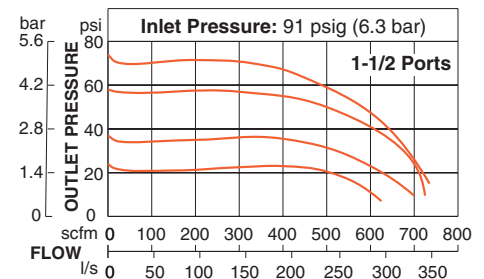
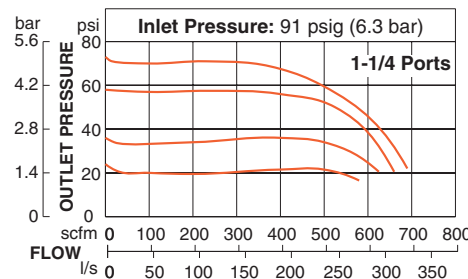
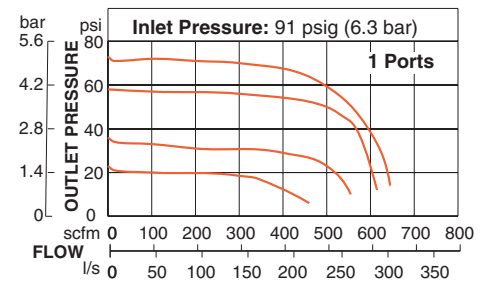
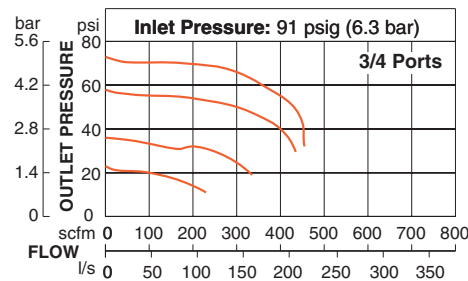

*Pressure Gauge included.
 Accessories ordered separately, refer to page G6.3-4.*

STANDARD SPECIFICATIONS (for regulators on this page):

| | | | |
|---------------------|--|-----------------------|--|
| Construction Design | Diaphragm Self-relieving | Pressure Gauge | 0 to 200 psig (0 to 14 bar) standard, 1/4-NPTF) gauge ports front and rear |
| Temperature | Ambient/Media: 40° to 175°F (4° to 79°C) | Construction Material | Body: Aluminum |
| Fluid Media | Compressed air | | Dome: Zinc |
| Operating Pressure | Inlet: Maximum 300 psig (21 bar) Outlet: Adjustable 0 to 200 psig (0 to 14 bar) | | Seals: Nitrile |
| Pilot Ports | 1/4-NPTF | | Valve: Brass Valve Cap: Nylon |

IMPORTANT NOTE: Please read carefully and thoroughly all of the **CAUTIONS, WARNINGS** on the inside back cover.



Online Version
02/01/21



www.rosscontrols.com

G2.21

In-line Premium High-Relief Remote Pilot Regulators

HIGH-CAPACITY Series

Port Sizes: 3/4, 1 & 1 1/4 – Flow to 400 scfm

| Port Size | Model Number | |
|-----------|--------------|------------|
| | NPTF Threads | G Threads |
| 3/4 | 5216A5007 | C5216A5007 |
| 1 | 5216A6007 | C5216A6007 |
| 1 1/4 | 5216A7007 | C5216A7007 |



| Port Size | Dimensions inches (mm) | | | | Weight† lb (kg) |
|---------------|------------------------|-------------|--------------|------------|--------------------|
| | A | B** | C*** | Depth† | |
| 3/4, 1, 1 1/4 | 4.18 (117) | 1.87 (47.5) | 3.99 (101.3) | 4.18 (106) | 6.44 (3.0) |

** Dome removal clearance: add 0.63 (16).

*** Cap removal clearance: add 0.5 (13).

† Less gauge.

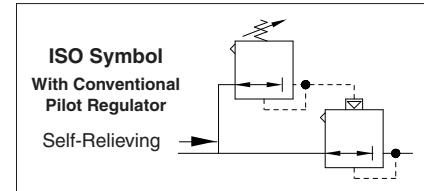
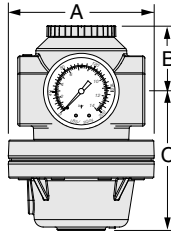

FLOW CHARTS

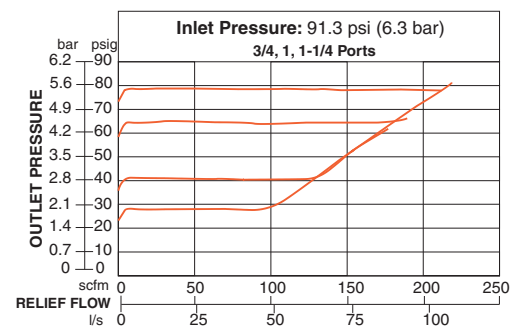
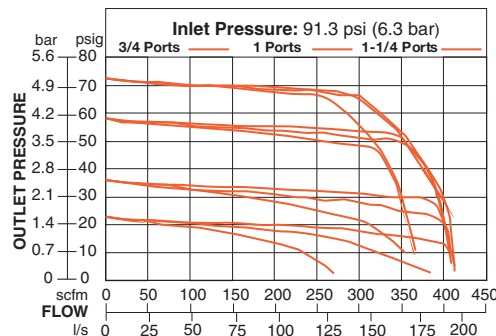

Pressure Gauge included.

Accessories ordered separately, refer to page G6.3-4.

STANDARD SPECIFICATIONS (for regulators on this page):

| | |
|---------------------|--|
| Construction Design | Diaphragm Self-relieving |
| Temperature | Ambient/Media: 0° to 158°F (-18° to 70°C) |
| Fluid Media | Compressed air |
| Operating Pressure | Inlet: Maximum 400 psig (28 bar) Outlet: Adjustable up to 250 psig (up to 17 bar) |
| Pressure Gauge | 0 to 200 psig (0 to 14 bar) standard, 1/4-NPTF (1/4 BSPP) gauge ports front and rear; 0 to 600 psig (0 to 40 bar) optional |

| | |
|-----------------------|-------------------------------|
| Construction Material | Body: Zinc |
| | Dome: Zinc |
| | Seals: Nitrile |
| | Valve: Brass |
| | Valve Cap: Glass filled Nylon |

IMPORTANT NOTE: Please read carefully and thoroughly all of the **CAUTIONS, WARNINGS** on the inside back cover.

In-line Remote Pilot Regulators

HIGH-CAPACITY Series

Port Sizes: 1½, 2 & 3 – Flow to 4000 scfm

| Flow to 850 scfm | | |
|------------------|--------------|------------|
| Port Size | Model Number | |
| | NPTF Threads | G Threads |
| 1½ | 5211B8027 | C5211B8027 |
| 2 | 5211B9007 | C5211B9007 |

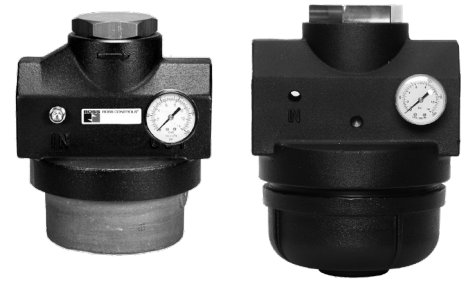

| Flow to 4000 scfm | | | |
|-------------------|-----------------|--------------|------------|
| Port Size | Seals | Model Number | |
| | | NPTF Threads | G Threads |
| 3 | Nitrile | 5211B9008 | C5211B9008 |
| 3 | Fluoroelastomer | 5X00B9021 | C5X00B9021 |

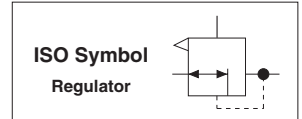

| Port Size | Dimensions inches (mm) | | | | Weight† lb (kg) |
|-----------|------------------------|------------|-----------|-----------|--------------------|
| | A | B | C | Depth† | |
| 1½, 2 | 6.4 (162) | 5.0 (127) | 3.0 (76) | 2.8 (71) | 8.94 (4.06) |
| 3 | 8.4 (214) | 7.36 (187) | 3.74 (95) | 8.0 (203) | 21.77 (9.88) |

† Less gauge.

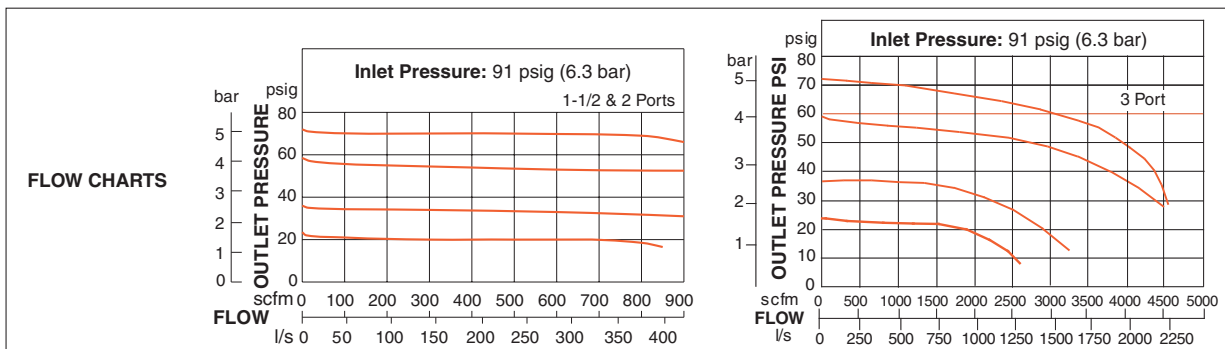
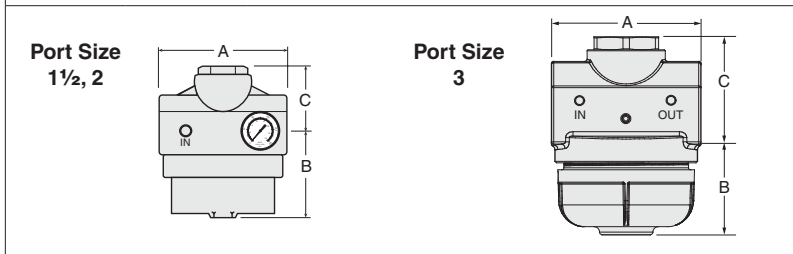

Pressure Gauge included.
Accessories ordered separately, refer to page G6.3-4.

STANDARD SPECIFICATIONS (for regulators on this page):

| | | | |
|---------------------|--|-----------------------|---|
| Construction Design | Piston Self-relieving | Pilot Ports | 1/4-NPTF |
| Temperature | Ambient/Media: 40° to 175°F (4° to 79°C) | Pressure Gauge | 0 to 200 psig (0 to 14 bar) standard, 1/4-NPTF gauge ports front and rear |
| Fluid Media | Compressed air | Construction Material | Body: Aluminum |
| Operating Pressure | Inlet: Maximum 300 psig (21 bar) Outlet: Adjustable 0 to 200 psig (0 to 14 bar) NOTE: Outlet pressure depends on the adjustment of the pilot regulator | | Dome: Aluminum |
| | Pilot Ports | | 1/4-NPTF |
| | | | Valve: Brass on 1/2" & 2" ports; Aluminum on 3" ports Valve Cap: Aluminum |

IMPORTANT NOTE: Please read carefully and thoroughly all of the **CAUTIONS, WARNINGS** on the inside back cover.



Online Version
02/01/21



www.rosscontrols.com

Port Sizes: 1/8 & 1/4 – Flow to 40 scfm

| Port Size | Port Threads | Pressure Range psig (bar) | | | |
|-----------|--------------|---------------------------|-----------------|-----------------|------------------|
| | | 1-15 (0.07-1.0) | 1-30 (0.07-2.1) | 1-50 (0.07-3.4) | 1-140 (0.07-9.6) |
| | | Model Number | Model Number | Model Number | Model Number |
| 1/8 | NPTF | 5210B1002 | 5210B1003 | 5210B1004 | 5210B1001 |
| | G | C5210B1002 | C5210B1003 | C5210B1004 | C5210B1001 |
| 1/4 | NPTF | 5210B2002 | 5210B2003 | 5210B2004 | 5210B2001 |
| | G | C5210B2002 | C5210B2003 | C5210B2004 | C5210B2001 |



| Port Size | Dimensions inches (mm) | | | | Weight† lb (kg) |
|-----------|------------------------|----------|----------|----------|--------------------|
| | A | B | C | Depth† | |
| 1/8, 1/4 | 1.6 (41) | 2.7 (68) | 0.4 (10) | 1.6 (41) | 0.24 (0.11) |

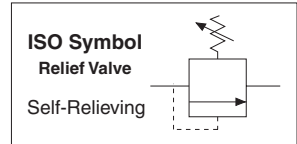
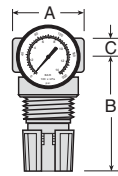

†Less gauge.

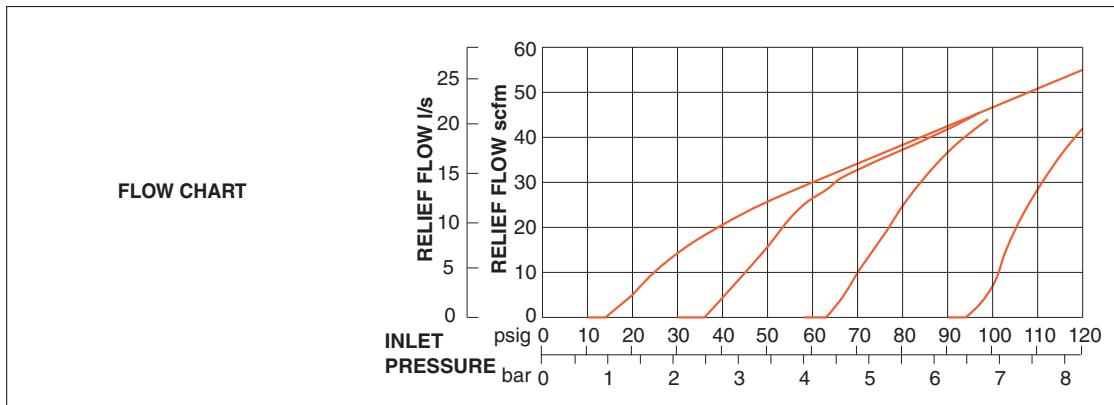

Relief Valves have maximum relief flows of 10 to 20 scfm (4.7 to 9.4 l/s).
For models with increased sensitivity at lower pressure, consult ROSS.

Pressure Gauge included.
Accessories ordered separately, refer to page G6.3-4.

STANDARD SPECIFICATIONS (for valves on this page):

| | | | |
|---------------------|--|-----------------------|--|
| Construction Design | Diaphragm Self-relieving | Panel Mounting | 1-3/16 inch (30 mm) hole required |
| Temperature | Ambient/Media: 40° to 125°F (4° to 52°C) | Construction Material | Body: Aluminum |
| Fluid Media | Compressed air | | Dome: Acetal |
| Operating Pressure | Inlet: Maximum 300 psig (21 bar) Outlet: Adjustable 1 to 140 psig (0.07 to 9.6 bar) | | Knob: Acetal |
| Pressure Gauge | 0 to 160 psig (0 to 11 bar); 1/8 NPT gauge ports front and rear | | Seals: Nitrile; Fluoroelastomer seals optional, consult ROSS |

IMPORTANT NOTE: Please read carefully and thoroughly all of the **CAUTIONS, WARNINGS** on the inside back cover.

Port Sizes: 1 – Flow to 450 scfm

| Port Size | Model Number | |
|-----------|--------------|------------|
| | NPTF Threads | G Threads |
| 1 | 5X00D6012 | C5X00D6012 |



| Port Size | Dimensions inches (mm) | | | | Weight lb (kg) |
|-----------|------------------------|-----------|----------|----------|----------------|
| | A | B | C | Depth | |
| 1 | 4.4 (111) | 4.8 (122) | 2.5 (62) | 2.9 (72) | 1.8 (0.8) |

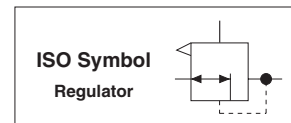
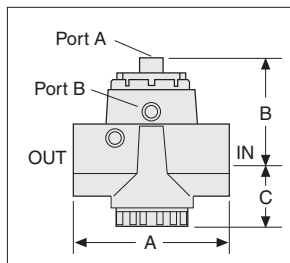

On the right is a typical circuit using the High-Flow Relief Valve. The circuit utilizes a remotely piloted “fill” regulator (port size 1 NPT) and a small, remotely mounted, pilot regulator with 1/4 NPT ports.

The required system pressure is set by adjusting the knob on the pilot regulator until the desired system pressure is shown on the pilot regulator’s gauge. An example system pressure of 50 psig was selected in the circuit.

Outlet pressure from the pilot regulator is sent to the fill regulator’s signal port and the Port 2 of the High-Flow Relief Valve. The Port 1 of the High-Flow Relief Valve is connected to the system, as shown, to monitor system pressure.

If the system pressure exceeds the pilot regulator setting (set-point), the High-Flow Relief Valve will begin to exhaust air after an approximate 2 psig (0.1 bar) rise above the set-point.

Should the system pressure drop below the set-point, the fill valve will open to supply air downstream and maintain the system at the set-point.

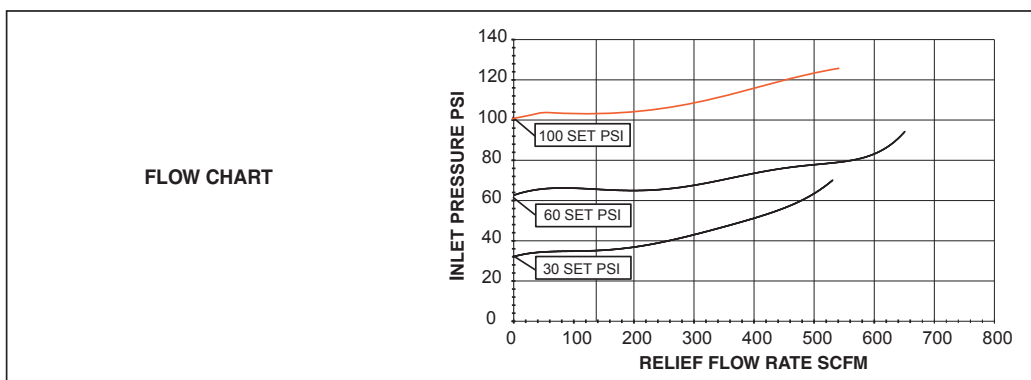
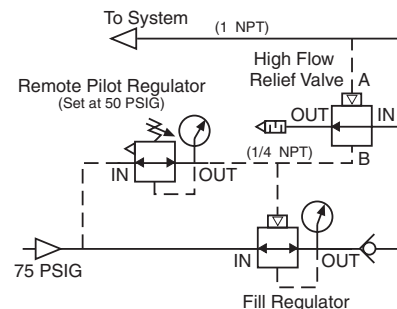

Accessories ordered separately, refer to page G6.3-4.

STANDARD SPECIFICATIONS (for valves on this page):

| | | | |
|---------------------|--|-----------------------|------------------|
| Construction Design | Diaphragm Self-relieving | Pilot Ports | 1/4 NPTF |
| Temperature | Ambient/Media: 40° to 175°F (4° to 79°C) | Construction Material | Body: Aluminum |
| Fluid Media | Compressed air | | Dome: Zinc |
| Operating Pressure | Inlet: Maximum 200 psig (14 bar) Outlet: Adjustable 0 to 200 psig (0 to 14 bar) | | Seals: Nitrile |
| Pressure Gauge | 0 to 200 psig (0 to 14 bar); 1/4 NPT gauge ports front and rear | | Valve: Brass |
| | | | Valve Cap: Nylon |

IMPORTANT NOTE: Please read carefully and thoroughly all of the **CAUTIONS, WARNINGS** on the inside back cover.

HOW TO ORDER

Choose your options (in red) to configure your model number.

RER1
A
1
A
100

| CONNECTOR | |
|---------------------|---|
| 6-Pin Brad Harrison | A |
| 5-Pin M12 | B |

| COMMAND INPUT | |
|---------------|---|
| 0-10 volts DC | 1 |
| 4-20 mA | 2 |

| MONITOR SIGNAL | |
|--------------------|---|
| 0-10 volts DC | A |
| 4-20 mA - sinking | B |
| 4-20 mA - sourcing | C |

| MAXIMUM CALIBRATED PRESSURE RANGE | |
|-----------------------------------|-----|
| 0-30 psig (0 to 2.1 bar) | 030 |
| 0-50 psig (0 to 3.5 bar) | 050 |
| 100 psig (0 to 6.9 bar) | 100 |
| 0-200 psig (0 to 13.8 bar) | 200 |
| 0-300 psig (0 to 20.7 bar) | 300 |
| 0-20 in Hg (vacuum) | V20 |



Accessories ordered separately, see below.

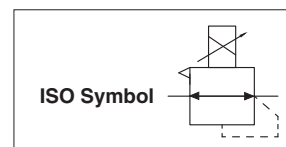

ACCESSORIES

Cables

For 6-Pin Brad Harrison Connector.

| Cable Length | Model Number* |
|----------------------|---------------|
| 6 feet (1.8 meters) | RER-CBL-6 |
| 12 feet (3.7 meters) | RER-CBL-12 |
| 25 feet (7.5 meters) | RER-CBL-25 |

*For cables for 5-Pin M12 connector, consult ROSS.



STANDARD SPECIFICATIONS (for valves on this page):

| | | | |
|---------------------------------|---|---|----------------------------------|
| Supply Voltage/Current | 15 – 24 volts DC/250 mA (required) | | Body: Zinc |
| Analog Monitor Signal: | Voltage: 0 – 10 volts DC@20 mA maximum Current: 4 – 20 mA sinking (sourcing optional) | Construction Material | Dome: Zinc |
| Command Signal Impedance: | Voltage: 4.7 kΩ Current: 100Q | | Housing: Aluminum; powder coated |
| Command Signal Voltage/Current: | 0 – 10 volts DC/4 – 20 mA | | Manifold: Brass |
| Electrical Connector: | 6-pin Brad Harrison or 5-pin M12 | | Seals: Fluorocarbon |
| Temperature | Ambient/Media: 32° to 158°F (0° to 70°C) | Accuracy: | < ± .25% F.S. |
| Fluid Media | Compressed air | Linearity/Hysteresis: | < ± .2% F.S. BFSL |
| Operating Pressure | Input: 29.9 in Hg to 300 psig (760 mm Hg to 21 bar) Output: 0 to 200 psi (0 to 14 bar) | Repeatability: | < ± .2% F.S. |
| | | <i>Note: High-pressure Proportional valve Q175 psi (12 bar) - inlet and exhaust ports reversed from picture shown</i> | |

IMPORTANT NOTE: Please read carefully and thoroughly all of the **CAUTIONS, WARNINGS** on the inside back cover.

E-P Proportional Valves with Volume Booster

RB Series

Port Sizes: 1½, 2 & 3 – Flow to 4000 scfm



RB 1 2 A RER1 A 1 A 100

| REGULATOR TYPE | |
|-----------------------------|---|
| 1/4 to 3/4 - Self Relieving | 1 |
| 3/4 to 1½ - Self Relieving | 2 |
| 1/4 to 1/2 - High-Relief | 3 |
| 3/4 to 1¼ - High-Relief | 4 |

| CONNECTOR | |
|---------------------|---|
| 6-Pin Brad Harrison | A |
| 5-Pin M12 | B |

| MAXIMUM CALIBRATED PRESSURE RANGE | |
|-----------------------------------|-----|
| 0-30 psig (0 to 2.1 bar) | 030 |
| 0-50 psig (0 to 3.5 bar) | 050 |
| 0-100 psig (0 to 6.9 bar) | 100 |
| 0-200 psig (0 to 13.8 bar) | 200 |
| 0-300 psig (0 to 20.7 bar) | 300 |
| 0-20 in Hg (vacuum) | V20 |

| INLET/OUTLET PORTS | | | |
|--------------------|---|-------|---|
| 1/4 NPTF | 2 | 1/4 G | B |
| 3/8 NPTF | 3 | 3/8 G | C |
| 1/2 NPTF | 4 | 1/2 G | D |
| 3/4 NPTF | 6 | 3/4 G | E |
| 1 NPTF | 8 | 1 G | F |
| 1¼ NPTF | J | 1¼ G | G |
| 1½ NPTF | K | 1½ G | H |

| GAUGE | |
|-------------------------------|---|
| Without Gauge | A |
| Gauge 0-200 psig (0-13.8 bar) | B |
| Gauge 0-600 psig (0-40 bar) | C |
| Gauge 0-30 psig (0-2 bar) | D |
| Gauge 0-60 psig (0-4 bar) | E |

For Electronic Gauge, consult ROSS.

| COMMAND INPUT | |
|---------------|---|
| 0-10 volts DC | 1 |
| 4-20 mA | 2 |

| MONITOR SIGNAL | |
|--------------------|---|
| 0-10 volts DC | A |
| 4-20 mA - sinking | B |
| 4-20 mA - sourcing | C |

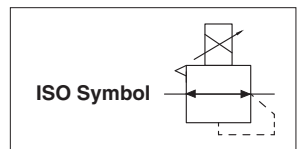

Accessories ordered separately, see below.

| Regulator Pressure Model | Inlet psi (bar) | Outlet psi (bar) | Relief scfm |
|--------------------------|-----------------|------------------|-------------|
| RB1 - RB2 | 300 (20.7) | 200 (13.8) | 627 |
| RB3 - RB4 | 400 (27.6) | 250 (17.3) | 200 |

Brass Inlet Filter (R37-R288) is included when purchasing a proportional-valve.
NOTE: Cable not included with the product, see choices below.



ACCESSORIES

Mounting Bracket Kit

| Regulator Type | Kit Number1 |
|----------------|-------------|
| Self Relieving | RER-BRK-1 |
| High-Relief | R-A37-381 |

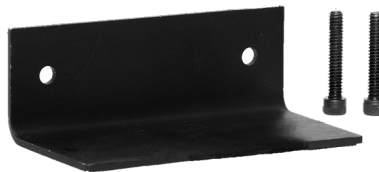

Cables

For 6-Pin Brad Harrison Connector.

| Cable Length | Model Number* |
|----------------------|---------------|
| 6 feet (1.8 meters) | RER-CBL-6 |
| 12 feet (3.7 meters) | RER-CBL-12 |
| 25 feet (7.5 meters) | RER-CBL-25 |

*For cables for 5-Pin M12 connector, consult ROSS.



STANDARD SPECIFICATIONS (for valves on this page):

| | | | | |
|---------------------------------|---|-----------------------|----------------------------------|-------------------|
| Supply Voltage/Current | 15 – 24 volts DC/250 mA (required) | Construction Material | Body: Zinc | |
| Analog Monitor Signal: | Voltage: 0 – 10 volts DC@20 mA maximum Current: 4 – 20 mA sinking (sourcing optional) | | Dome: Zinc | |
| Command Signal Impedance: | Voltage: 4.7 kΩ Current: 100Q | | Housing: Aluminum; powder coated | |
| Command Signal Voltage/Current: | 0 – 10 volts DC/4 – 20 mA | | Manifold: Brass | |
| Electrical Connector: | 6-pin Brad Harrison or 5-pin M12 | | Seals: Fluorocarbon | |
| Temperature | Ambient/Media: 32° to 158°F (0° to 70°C) | | Transducer: Silicon, Aluminum | |
| Fluid Media | Compressed air | | Valve: Nickel-plated Brass | |
| Operating Pressure | Input: 29.9 in Hg to 300 psig (760 mm Hg to 21 bar) Output: 0 to 200 psi (0 to 14 bar) | | Accuracy: | < ± .25% F.S. |
| | | | Linearity/Hysteresis: | < ± .2% F.S. BFSL |
| | | | Repeatability: | < ± .06% F.S. |

IMPORTANT NOTE: Please read carefully and thoroughly all of the **CAUTIONS, WARNINGS** on the inside back cover.



Online Version
02/01/21



www.rosscontrols.com

G2.27



ACCESSORIES



ROSS CONTROLS

| SILENCERS | | | | | | | |
|-----------|-------------|--------------|--------------|---------------------|------------------------|-----------|----------------|
| Port Size | Thread Type | Model Number | | Avg. C _v | Dimensions inches (mm) | | Weight lb (kg) |
| | | NPT Threads | R/Rp Threads | | Length | Width | |
| 1/8 | Male | 5500A1003 | D5500A1003 | 1.2 | 0.9 (21) | 2.0 (51) | 0.1 (0.1) |
| 1/4 | Male | 5500A2003 | D5500A2003 | 2.1 | 0.9 (21) | 2.2 (55) | 0.1 (0.1) |
| 3/8 | Male | 5500A3013 | D5500A3013 | 2.7 | 0.9 (21) | 2.2 (55) | 0.1 (0.1) |
| | | 5500A3003 | D5500A3003 | 4.3 | 1.3 (32) | 3.5 (88) | 0.2 (0.1) |
| 1/2 | Male | 5500A4003 | D5500A4003 | 4.7 | 1.3 (32) | 3.6 (91) | 0.2 (0.1) |
| 3/4 | Male | 5500A5013 | D5500A5013 | 5.1 | 1.3 (32) | 3.6 (92) | 0.2 (0.1) |
| | | 5500A5003 | D5500A5003 | 11.5 | 2.0 (51) | 5.3 (135) | 0.6 (0.3) |
| 1 | Male | 5500A6003 | D5500A6003 | 14.6 | 2.0 (51) | 5.4 (138) | 0.6 (0.3) |
| 1¼ | Male | 5500A7013 | D5500A7013 | 16.4 | 2.0 (51) | 5.5 (140) | 0.6 (0.3) |
| | Female | 5500A7001 | D5500A7001 | 24 | 2.5 (64) | 5.7 (144) | 1.0 (0.5) |
| 1½ | Female | 5500A8001 | D5500A8001 | 29.9 | 2.5 (64) | 5.7 (144) | 1.0 (0.5) |
| 2 | Female | 5500B9001 | D5500B9001 | 34.2 | 3.0 (76) | 6.6 (168) | 1.5 (0.7) |
| 2½ | Female | 5500A9002 | D5500A9002 | 103.7 | 4.0 (102) | 5.7 (145) | 2.9 (1.4) |

Pressure Range: 0 to 290 psig (0 to 20 bar) maximum. **Flow Media:** Filtered air.



Port size
1/8 thru 2



Port size 2½



| Stainless Steel SILENCERS | | | | | | | | |
|---------------------------|-------------|--------------|--------------|---------------------|------------------------|-------------|----------------|--|
| Port Size | Thread Type | Model Number | | Avg. C _v | Dimensions inches (mm) | | Weight lb (kg) | Construction |
| | | NPT Threads | R/Rp Threads | | Length | Width | | |
| 1/4 | Male | 5500B2004 | D5500B2004 | 1.44 | 1.75 (44.5) | 0.56 (14.2) | 0.05 (0.23) | Stainless steel |
| 1/2 | Male | 5500B4004 | D5500B4004 | 3.01 | 2.75 (69.7) | 0.87 (22.1) | 0.25 (0.11) | |
| 1 | Male | 5500B6004 | D5500B6004 | 10.41 | 3.87 (98.3) | 1.31 (33.3) | 0.45 (0.20) | NPT - Stainless steel R - Nickel plated cold rolled steel |
| 2 | Male | 5500A9004 | D5500A9004 | 28.11 | 5.50 (139.7) | 2.37 (60.2) | 1.5 (0.68) | Nickel plated cold rolled steel |

Supplied with a standard pipe thread fitting for attaching directly to the exhaust ports of air-operated equipment.
Pressure Range: 0 to 175 psig (0 to 12.3 bar) maximum. **Flow Media:** Filtered air.



| SILENCERS for Stainless Steel L-O-X® Air Entry Assemblies | | | | | | | |
|---|-------------|--------------|-------------|---------------------|------------------------|-----------|---|
| Port Size | Thread Type | Model Number | | Avg. C _v | Dimensions inches (mm) | | Description |
| | | NPT Threads | BSP Threads | | Length | Width | |
| 1/4 | Male | 5500A2005 | D5500A2005 | 1.5 | 1.50 (38) | 0.67 (17) | Pressure Range: 0 to 125 psig (0 to 8.6 bar) maximum. Seals: Nitrile. |
| 1/2 | Male | 5500A4005 | D5500A4005 | 3.5 | 2.17 (55) | 0.94 (24) | |
| 1 | Male | 5500A6005 | D5500A6005 | 5.7 | 2.95 (75) | 1.41 (36) | |



| Noise-Reduction SILENCERS for DM ¹ & DM ² ® Series C Double Valves | | | | | | | | |
|--|------------|-------------|--------------|-------------|------------------------|----------------|----------------|---------------|
| Valve Model | Basic Size | Kit Number* | | Flow scfm | Dimensions inches (mm) | | | |
| | | NPT Threads | R/Rp Threads | | A | B (NPT) | B (R) | C |
| DM Series C | 2 | 2324H77 | 2329H77 | 800 (378) | 4.34 (110.2) | 19.06 (484.1) | 21.40 (543.6) | 7.27 (184.7) |
| | 4 | 2324H77 | 2329H77 | 800 (378) | 4.34 (110.2) | 19.06 (484.1) | 21.40 (543.6) | 7.27 (184.7) |
| | 8 | 2325H77 | 2329H77 | 800 (378) | 5.41 (137.4) | 21.18 (538.0) | 23.52 (597.4) | 8.41 (213.6) |
| | 12 | 2326H77 | 2330H77 | 2080 (982) | 6.74 (117.2) | 25.85 (656.6) | 28.20 (716.3) | 10.66 (270.8) |
| | 30 | 2327H77 | 2331H77 | 7200 (3398) | 9.85 (250.2) | 41.55 (1055.4) | 41.55 (1055.4) | 13.47 (342.1) |

Pressure Range: 125 psig (8.6 bar) maximum.
* Kits include all plumbing required for installation.
Reduces the Exponentially Perceived Noise (EPNdB), Impact noise reduction in the 35–40 dB range
Recommended for air exhaust applications for pressures up to 125 psig (8.6 bar)
Pressure Range – 125 psig (8.6 bar) maximum

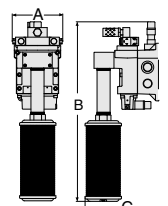

IMPORTANT NOTE: Please read carefully and thoroughly all of the **CAUTIONS, WARNINGS** on the inside back cover.

| Noise-Reduction SILENCERS for DM ² ® Series D Double Valves | | | | | | Description |
|--|-------------|--------------|-------------|------------------------|-----------|---|
| Valve Basic Size | Thread Type | Kit Number*# | Flow scfm | Dimensions inches (mm) | | |
| | | | | Height | Width | |
| 4 | NPT | 2324H77 | 800 (378) | 19.1 (484) | 4.4 (110) | Reduces the Exponentially Perceived Noise (EPNdB), Impact noise reduction in the 35–40 dB range Recommended for air exhaust applications for pressures up to 125 psig (8.6 bar) Pressure Range – 125 psig (8.6 bar) maximum |
| | BSPT | 2329H77 | 800 (378) | 21.4 (544) | 4.4 (110) | |
| 8 | NPT | 2325H77 | 800 (378) | 21.2 (538) | 5.4 (138) | |
| | BSPT | 2330H77 | 800 (378) | 23.5 (598) | 5.4 (138) | |
| 12 | NPT | 2326H77 | 2080 (982) | 25.9 (657) | 6.8 (117) | |
| | BSPT | 2331H77 | 2080 (982) | 28.2 (716) | 6.8 (117) | |
| 30 | NPT | 2327H77 | 7200 (3398) | 41.6 (1056) | 9.9 (250) | |
| | BSPT | 2332H77 | | | | |

* Kits include all plumbing required for installation.
Exhaust flange kit required, see below ordering information.



| Exhaust Flange Kits for Noise Reduction Silencers | Valve Basic Size | Port Size | Kit Number | | Used when installing noise reduction silencers |
|---|------------------|-----------|-------------|-----------|--|
| | | | NPT Threads | G Threads | |
| | 4 | 1 | 726B25 | D276B25 | |
| 8 | 1 | 617B25 | D617B25 | | |
| 12 | 1½ | 619B25 | D619B25 | | |
| 30 | 2½ | 621B25 | D621B25 | | |

Electrical CONNECTORS & CORD Sets

| Connection Type | EN 175301-803 Connector | | Fitting Connection | Cord Type/Termination | | Length meters (feet) | Cord Diameter | Model Number | | | Cord Quantity | | | | | | |
|-----------------|-------------------------|------|--------------------|-----------------------|--------------|----------------------|---------------|---------------|-------------------|-----------|---------------|---------|------|--------|-----------|-----------|-----------|
| | Option | Form | | End 1 | End 2 | | | Without Light | Lighted Connector | | | | | | | | |
| | | | | | | | | | 24 V DC | 120 V AC | | | | | | | |
| Solenoid | Connector Only | A | – | – | – | – | – | 937K87 | 936K87-W | 936K87-Z | – | | | | | | |
| | | | 1/2" NPT conduit | – | – | – | – | 723K77 | 724K77-W | 724K77-Z | – | | | | | | |
| | | B | – | – | – | – | – | 372K77 | 328K77-W | 328K77-Z | – | | | | | | |
| | | C | – | – | – | – | – | 2452K77 | 2453K77-W | 2453K77-Z | – | | | | | | |
| | Prewired Connector | A | – | Connector | Flying leads | 2 (6.5) | 6-mm | 721K77 | 720K77-W | 720K77-Z | 1 | | | | | | |
| | | | | | | | 10-mm | 371K77 | 383K77-W | 383K77-Z | 1 | | | | | | |
| | | | | | | 5 (16.4) | – | 2243H77 | – | – | 2 | | | | | | |
| | | | | | | 10 (32.8) | – | 2244H77 | – | – | 2 | | | | | | |
| | | B | – | Connector | Flying leads | 2 (6.5) | 10-mm | 266K77 | 267K77-W | 267K77-Z | 1 | | | | | | |
| | | | | | | | | C | – | Connector | Flying leads | 2 (6.5) | 5-mm | – | 2476K77-W | 2476K77-Z | 1 |
| | | | | | | | | | | | | | | 3 (10) | 8-mm | 2449K77 | 2450K77-W |



CAUTIONS: Do not use electrical connectors with surge suppressors, as this may increase valve response time when de-actuating the solenoids.

PRESSURE Indicators

| Pop-Up (Visual) Indicator | Model Number | Port Threads | May be installed on all valves with pressure sensing port. Provides a means to verify the release of downstream pressure to next obstruction. |
|---------------------------|--------------|--------------|---|
| | 988A30 | 1/8 NPT | |



| Stainless Steel Visual Indicator | Model Number | Port Threads | Dimensions inches (mm) | | Weight lb (kg) | Hexagon Nut 1.2 (30.5) Across Flats Port |
|----------------------------------|--------------|--------------|------------------------|-------------|----------------|---|
| | | | A | B | | |
| | 1155H30 | 1/8 NPT | 2.33 (59.3) | 1.00 (25.4) | 0.22 (0.1) | |



316 Stainless Steel Body, Internals and Springs, Nitrile Seals
Visual Indicator piston, Acetal; Visual Indicator assembly, Acetal with acrylic lens

| Status Indicator | Model Number | The Status Indicator pressure switch actuates when the valve is in a ready-to-run condition and de-actuates when the valve is in a lockout condition or when the inlet air pressure has been removed. |
|------------------|--------------|---|
| | 670B94 | |



IMPORTANT NOTE: Please read carefully and thoroughly all of the **CAUTIONS, WARNINGS** on the inside back cover.

PRESSURE SWITCHES For Verification Of Downstream Pressure Release

| Pressure Switch Type | Connection Type | Model Number | Port Threads | EN Connector Pinout | M12 Connector Pinout |
|--|---------------------------------|--------------|--------------|---------------------|----------------------|
| Pressure Switches (Electrical) for Energy Release Verification | EN 175301-803 Form A | 586A86 | 1/8 NPT | | |
| | Pressure Switch M12 | 1153A30 | M10x1 | | |
| | Solid State Pressure Sensor M12 | 1335B30W | M10x1 | | |
| Redundant Downstream Feedback Switch for Energy Release Verification | EN 175301-803 Form A | RC026-13 | 3/8 NPT | | |

Factory preset, 5 psi (0.3) - falling



May be installed on all valves with pressure sensing port.
Provides means to verify the release of downstream pressure to next obstruction.

| Stainless Steel Pressure Switch | Inlet Port Size | Model Number | Weight lb (kg) |
|---------------------------------|-----------------|--------------|----------------|
| | 1/8 | 1162A30 | 0.23 (.01) |

316 Stainless Steel Body, Nitrile Seals, DPDT (Double-Pole Double-Throw Switch)
Factory preset 5 psi (falling)



NPT port threads.

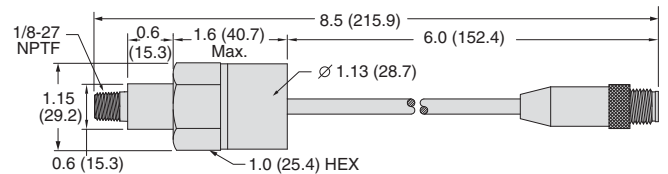

Digital PRESSURE TRANSDUCER For Digital Pressure Readout

| Digital Pressure Transducer | Threads | Model Number | Pressure Range psig (bar) | Description | | | |
|-----------------------------|---------|--------------|---------------------------|-------------------------|-----------------------|-------------------------|----------------|
| | | | | Electrical Output | Electrical Connection | Pressure Port Size/Type | Weight lb (Kg) |
| | NPT | 760B94 | 0 (0) to 145 (10) | (1) PNP with (1) 4-20ma | M8, 4 Pin | 1/8 NPT male | 0.099 (0.045) |

Analog 4-20mA Output, and Transistor Switching Output.

Sensor Pinout with Analog Output

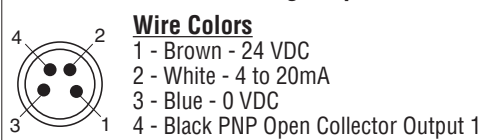

Pressure GAUGES

| Pressure Gauges (Center Back Mounting) | Type/Material | Port Size | Model Number | | Pressure Range psig (bar) | Case Diameter inches (mm) |
|---|-------------------|------------|--------------|--------------|------------------------------|------------------------------|
| | | | NPT Threads | G Threads | | |
| | Standard Aluminum | 1/8 | 5400A1002 | D5400A1002 | 0-160 (0-11) | 1.7 (43) |
| 1/4 | | 5400A2010 | D5400A2010 | 0-60 (0-4) | 2.0 (51) | |
| 1/4 | | 5400A2011 | D5400A2011 | 0-200 (0-14) | 2.0 (51) | |
| 1/4 | | 5400A2012 | D5400A2012 | 0-300 (0-20) | 2.0 (51) | |
| Liquid Filled Stainless Steel | 1/4 | 5400A2014 | D5400A2014 | 0-160 (0-11) | 2.5 (64) | |
| | 1/4 | 5400A2015* | D5400A2015* | 0-160 (0-11) | 2.0 (51) | |

* Green shade between 40-70 psi (2.7-4.8 bar).



Multiple Lock-out Device

| Model Number | Description |
|--------------|---|
| 356A30 | For use with any ROSS model valve with L-O-X® capability. Allows use of multiple lockout devices on a single energy isolation device. |





INDICATOR Light Kits for valves with Solenoid Controlled Pacer Pilot

| Indicator Light Kits for 27 & 21 Series and SV27 & SV27 PO Check Valves | Kit Number | | | Indicator Light  |
|---|-------------|------------------------------|-----------------------|---|
| | 24 volts DC | 110-120 volts AC 50-60 Hz | 220 volts 50-60 Hz | |
| | 862K87-W | 862K87-Z | 862K87-Y | |

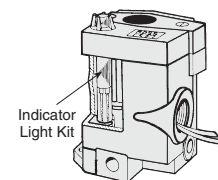
To visually verify valve operation indicator lights are available in kit form. The indicator light extends through the solenoid or pilot cover and is illuminated when the solenoid is energized. Such lights are standard on double solenoid valves. Indicator light kit is available for single solenoid models.



| Manual Override Kits | Flush Button | |  | Extended Button | |  | Extended Button with Palm | |  |
|-------------------------|--------------|------------|---|-----------------|------------|--|---------------------------|------------|---|
| | Locking Type | Kit Number | | Locking Type | Kit Number | | Locking Type | Kit Number | |
| | Non-Locking | 790K87 | | Non-Locking | 791K87 | | Non-Locking | 984H87 | |
| Locking | 792K87 | Locking | — | Locking | — | | | | |

Flush flexible manual overrides are standard on single solenoid models. Double solenoid models have flush metal-button overrides. Both types are non-locking. Each of the buttons in the override kits below is made of metal and is spring-returned. The locking type button, however, can be kept in the actuated position by turning the slot in the top of the button with a screwdriver.

CONNECTORS & CORD Sets

| Connection Type | Connector Option | Connector Form | Fitting Connection | Cord Type/Termination | | Length meters (feet) | Cord Diameter | Model Number | | Cord Quantity |
|-----------------|--------------------|-----------------------------|--------------------|-----------------------|--------------|----------------------|---------------|---------------|-------------------------------|---------------|
| | | | | End 1 | End 2 | | | Without Light | Lighted Connector 24 Volts DC | |
| Solenoid | Connector Only | EN 175301-803 Form A | - | - | - | - | - | 937K87 | 936K87-W | - |
| | | | 1/2" NPT conduit | - | - | - | - | 723K77 | 724K77-W | - |
| | Prewired Connector | EN 175301-803 Form A | - | Connector | Flying leads | 2 (6.5) | 6-mm | 721K77 | 720K77-W | 1 |
| | | | | | | 5 (16.4) | - | 2243H77 | - | 2 |
| | | | | | | 10 (32.8) | - | 2244H77 | - | 2 |
| Sensor | Prewired Connector | M12 5-pin, straight A-coded | - | Female | Flying leads | 5 (16.4) | - | 2644B77 | - | 2 |
| | | | | | Male | 5 (16.4) | - | 2645B77 | - | 2 |
| | | | | | Flying leads | 10 (32.8) | - | 2370B77 | - | 2 |
| | | | | | Male | 10 (32.8) | - | 2371B77 | - | 2 |



CAUTIONS: Do not use electrical connectors with surge suppressors, as this may increase valve response time when de-actuating the solenoids.

General Information

Approvals and Certifications

ROSS products are designed to meet a number of industrial standards, including the Canadian Standards Association (C.S.A.) guidelines.

For certifications or information and on specific product approvals, visit ROSS' website at www.rosscontrols.com.

Information or Technical Assistance

For additional information or application assistance concerning ROSS products, visit ROSS' website at www.rosscontrols.com, consult ROSS or your local ROSS distributor (see contact information on the back cover).

Order Placement

For order placement, consult ROSS or your local ROSS distributor.

For a current list of countries and local distributors, visit ROSS' website at www.rosscontrols.com.

CAUTIONS, WARNINGS And STANDARD WARRANTY

ROSS OPERATING VALVE, ROSS CONTROLS®, ROSS DECCO®, and AUTOMATIC VALVE INDUSTRIAL, collectively the “ROSS Group”.

PRE-INSTALLATION or SERVICE

1. Before servicing a valve or other pneumatic component, be sure all sources of energy are turned off, the entire pneumatic system is shut down and exhausted, and all power sources are locked out (ref: OSHA 1910.147, EN 1037).
2. All ROSS Group Products, including service kits and parts, should be installed and/or serviced only by persons having training and experience with pneumatic equipment. Because any product can be tampered with and/or need servicing after installation, persons responsible for the safety of others or the care of equipment must check ROSS Group Products on a regular basis and perform all necessary maintenance to ensure safe operating conditions.
3. All applicable instructions should be read and complied with before using any fluid power system to prevent harm to persons or equipment. In addition, overhauled or serviced valves must be functionally tested prior to installation and use. If you have any questions, call your nearest ROSS Group location.
4. Each ROSS Group Product should be used within its specification limits. In addition, use only ROSS Group components to repair ROSS Group Products.

WARNINGS: *Failure to follow these instructions can result in personal injury and/or property damage.*

FILTRATION and LUBRICATION

1. Dirt, scale, moisture, etc., are present in virtually every air system. Although some valves are more tolerant of these contaminants than others, best performance will be realized if a filter is installed to clean the air supply, thus preventing contaminants from interfering with the proper performance of the equipment. The ROSS Group recommends a filter with a 5-micron rating for normal applications.
2. All standard ROSS Group filters and lubricators with polycarbonate plastic bowls are designed for compressed air applications only. Use the metal bowl guard, where provided, to minimize danger from high pressure fragmentation in the event of bowl failure. Do not expose these products to certain fluids, such as alcohol or liquefied petroleum gas, as they can cause bowls to rupture, creating a combustible condition and hazardous leakage. Immediately replace crazed, cracked, or deteriorated bowls.
3. Only use lubricants which are compatible with materials used in the valves and other components in the system. Normally, compatible lubricants are petroleum base oils with oxidation inhibitors, an aniline

point between 180°F (82°C) and 220°F (104°C), and an ISO 32, or lighter, viscosity. Avoid oils with phosphate type additives which can harm polyurethane components, potentially leading to valve failure which risks personal injury, and/or damage to property.

WARNINGS: *Failure to follow these instructions can result in personal injury and/or property damage.*

AVOID INTAKE/EXHAUST RESTRICTION

1. Do not restrict air flow in the supply line. To do so could reduce the pressure of the supply air below minimum requirements for the valve and thereby causing erratic action.
2. Do not restrict a valve's exhaust port as this can adversely affect its operation. Exhaust silencers must be resistant to clogging and must have flow capacities at least as great as the exhaust capacities of the valves. Contamination of the silencer can result in reduced flow and increased back pressure.

WARNINGS: *Failure to follow these instructions can result in personal injury and/or property damage.*

SAFETY APPLICATIONS

1. Mechanical Power Presses and other potentially hazardous machinery using a pneumatically controlled clutch and brake mechanism must use a press control double valve with a monitoring device. A double valve without a self-contained monitoring device should be used only in conjunction with a control system which assures monitoring of the valve. All double valve installations involving hazardous applications should incorporate a monitoring system which inhibits further operation of the valve and machine in the event of a failure within the valve mechanism.
2. Safety exhaust (dump) valves without a self-contained monitoring device should be used only in conjunction with a control system which assures monitoring of the valve. All safety exhaust valve installations should incorporate a monitoring system which inhibits further operation of the valve and machine in the event of a failure within the valve mechanism.
3. Per specifications and regulations, the ROSS L-O-X® and L-O-X® with EEZ-ON®, N06 and N16 Series operation products are defined as energy isolation devices, NOT AS EMERGENCY STOP DEVICES.

WARNINGS: *Failure to follow these instructions can result in personal injury and/or property damage.*

STANDARD WARRANTY

All products sold by the ROSS Group are warranted for a one-year period [with the exception of Filters, Regulators and Lubricators (“FRLs”) which are warranted for a period of seven (7) years] from the date of purchase. All products are, during their respective warranty periods, warranted to be free of defects in material and workmanship. The ROSS Group’s obligation under this warranty is limited to repair, replacement or refund of the purchase price paid for products which the ROSS Group has determined, in its sole discretion, are defective. All warranties become void if a product has been subject to misuse, misapplication, improper maintenance, modification or tampering. Products for which warranty protection is sought must be returned to the ROSS Group freight prepaid.

THE WARRANTY EXPRESSED ABOVE IS IN LIEU OF AND EXCLUSIVE OF ALL OTHER WARRANTIES AND THE ROSS GROUP EXPRESSLY DISCLAIMS ALL OTHER WARRANTIES EITHER EXPRESSED OR IMPLIED WITH RESPECT TO MERCHANTABILITY OR FITNESS FOR A PARTICULAR PURPOSE. THE ROSS GROUP MAKES NO WARRANTY WITH RESPECT TO ITS PRODUCTS MEETING THE PROVISIONS OF ANY GOVERNMENTAL OCCUPATIONAL SAFETY AND/OR HEALTH LAWS OR REGULATIONS. IN NO EVENT IS THE ROSS GROUP LIABLE TO PURCHASER, USER, THEIR EMPLOYEES OR OTHERS FOR INCIDENTAL OR CONSEQUENTIAL DAMAGES WHICH MAY RESULT FROM A BREACH OF THE WARRANTY DESCRIBED ABOVE OR THE USE OR MISUSE OF THE PRODUCTS. NO STATEMENT OF ANY REPRESENTATIVE OR EMPLOYEE OF THE ROSS GROUP MAY EXTEND THE LIABILITY OF THE ROSS GROUP AS SET FORTH HEREIN.





AMERICAS

U.S.A.

ROSS CONTROLS

+1-248-764-1800

sales@rosscontrols.com

www.rosscontrols.com

Customer Service

1-800-GET-ROSS (438-1800)

Technical Service

1-888-TEK-ROSS (835-7677)

Canada

ROSS CANADA

+1-416-251-7677

sales@rosscanada.com

www.rosscanada.com

6077170 CANADA INC.

AN INDEPENDENT REPRESENTATIVE

Brazil

ROSS BRASIL

+55-11-4335-2200

vendas@rosscontrols.com

www.rosscontrols.com.br

EUROPE

Germany

ROSS EUROPA GmbH

+49-6103-7597-100

sales@rosseuropa.com

www.rosseuropa.com

United Kingdom

ROSS UK Ltd.

+44 (0)1254 872277

sales.uk@rosscontrols.com

www.rossuk.co.uk

France

ROSS FRANCE SAS

+33-1-49-45-65-65

sales@rossfrance.com

www.rossfrance.com

ASIA & PACIFIC

Japan

ROSS ASIA K.K.

+81-42-778-7251

custsvc.ra@rosscontrols.com

www.rossasia.co.jp

India

ROSS CONTROLS INDIA Pvt. Ltd.

+91-44-2624-9040

sales.ri@rosscontrols.com

www.rosscontrols.com

China

ROSS CONTROLS (CHINA) Ltd.

+86-21-6915-7942

sales.cn@rosscontrols.com

www.rosscontrolschina.com

ROSS CONTROLS COMPANIES

U.S.A.

AUTOMATIC VALVE

+1-248-474-6700

avc@automaticvalve.com

www.automaticvalve.com

Germany

manufactIS

+49 (0)201 316843-0

info@manufactis.net

www.manufactis.net

U.S.A.

ROSS DECCO

+1-248-764-1800

decco.sales@rosscontrols.com

www.rossdecco.com United King-

dom

ROSS PNEUMATROL

+44 (0)1254 872277

sales@pneumatrol.com

www.pneumatrol.com

Full-Service Global Locations

There are ROSS Distributors Throughout the World

To meet your requirements across the globe, ROSS distributors are located throughout the world. Through ROSS or its distributors, guidance is available for the selection of ROSS products, both for those using fluid power components for the first time and those designing complex systems.

Other literature is available for engineering, maintenance, and service requirements.

If you need products or specifications not shown in this catalog, please visit ROSS' website, contact ROSS or your ROSS distributor. The ROSS Support Team will be happy to assist you in selecting the best product for your application.

For a current list of countries and local distributors, visit ROSS' at www.rosscontrols.com.